



6 kg Washing Machine
P35106SKS2WA

INSTRUCTIONS:

Please read and keep safe for future use.

Please read these instructions first before using your appliance

Please take some time to read this user manual before using your appliance, to ensure you know how to safely operate the controls and functions.

Carefully follow unpacking and installation instructions to ensure the appliance is correctly connected and fitted prior to use.

General safety instructions

This section contains safety instructions that will help protect from risk of personal injury or property damage.

Our company shall not be liable for any damages that may arise in case of failure to follow these instructions.

- ▶ Always have the installation and repairing procedures carried out by the Authorised Service Agent.
- ▶ Only use original spare parts and accessories.
- ▶ Unless explicitly stated in the user's manual, do not repair or replace any part of any product.
- ▶ Do not make technical modifications in the product.

& 1.1 Intended Purpose

- ▶ This product is designed to be used in indoor areas, homes and similar locations. For example;
 - Personnel kitchens of stores, offices and other work environments;
 - Farmhouses;
 - By customers of hotels, motels and other accommodation facilities
 - Bed and breakfasts, hostel-like environments
 - Common areas of apartment blocks or laundries

Use the product only for washing textiles with a machine-washable label attached by the manufacturer. The product is not intended for commercial use.

&1.2 Safety of children, vulnerable persons and pets

- ▶ This product can be used by children at and above 8 years old and by persons whose physical, sensory or mental capabilities were not fully developed or who lack experience and knowledge provided that they are supervised or trained on the safe usage of the product and the risks it brings out.
- ▶ Children under the age of 3 should be kept away unless continuously supervised.
- ▶ Electrical products are dangerous for the children. Children or pets should not play with, climb on top or inside the product. Check inside the product before use.
- ▶ Use child lock to prevent children from intervening with the product.
- ▶ Do not forget to close the loading door when leaving the room where the product is located. Children and pets may get locked inside and drown.
- ▶ Children should not perform cleaning and user maintenance works without an adult's supervision.
- ▶ Keep packaging materials away from children. Danger of injury and drowning.
- ▶ Keep all detergents and additives used for the product away from children's reach.
- ▶ Cut the power cable and break and deactivate the locking mechanism of the loading door before disposing of the product for children's safety.

1.3 Electrical safety

- ▶ Product should be unplugged during installation, maintenance, cleaning and repair procedures.
- ▶ If the power cable is damaged, it must be replaced by the authorized service in order to avoid possible risks.
- ▶ Do not tuck the power cable under and behind the product. Do not place heavy objects on the power cable. Do not over bend, crush and touch the power cable to sources of heat.
- ▶ Do not use extension cables, multi sockets or adaptors for powering the

product.

- ▶ The plug should be easily accessible. If this is not possible, follow the electricity regulations of the electrical wiring the product is connected to, and there should be a mechanism (fuse, switch, contact breaker, etc.) to separate all poles from the mains.
- ▶ Do not touch the plug with wet hands.
- ▶ Unplug the appliance by holding and pulling the plug, not its cord.
- ▶ Make sure the plug is not wet, dirty or dusty.

& 1.4 Moving Safety

- ▶ Unplug the product before moving, remove the water outlet and water main connections. Drain any water left inside the product.
- ▶ The product is heavy, do not move alone. Do not hold extruding parts such as the laundry loading door to lift and move the product. The upper tray should be tightly fixed for moving.
- ▶ Your product is heavy; it should be carried carefully by two people if a staircase is involved. It may cause injuries if your product falls on you. Do not hit and drop the product while carrying.
- ▶ Carry the product in an upright position.
- ▶ Make sure that the hoses as well as the power cable are not folded, pinched or crushed after the product is fitted into its place after installation or cleaning procedures.

& 1.5 Installation Safety

- ▶ Check the information on the manual and installation instructions to prepare the product for installation and make sure the electrical mains, clean water mains and water outlet are suitable. If not, call a qualified electrician and plumber to have them make the necessary arrangements. These operations are the responsibility of the customer.
- ▶ Check for any damages before installing the product. Do not go ahead with the installation if the product is damaged.
- ▶ Injuries may occur if hands are put into uncovered slots. Close the holes of the transportation safety bolts with plastic plugs.
- ▶ Do not install or leave the product at locations where it may be exposed to external environment conditions.

- ▶ Do not install the product at locations where the temperature drops below 0°C.
- ▶ Do not place the product on a carpet or similar surface. It would create fire hazard since it cannot receive air from underneath.
- ▶ Place the product on a clean, even and hard floor and balance with the adjustable feet.
- ▶ Connect the product to a grounding plug protected by a fuse suitable to the current values on the type label. Make sure the grounding is carried out by an expert electrician. Do not use the product without suitable grounding to local/national regulations.
- ▶ Plug the product in a socket with voltage and frequency values suitable to those indicated on the type label.
- ▶ Do not plug the product in loose, displaced, broken, dirty, oily sockets or sockets with risk of water contact.
- ▶ Use the new hose set provided with the product. Do not re-use old hose sets. Do not make additions to the hoses.
- ▶ Fit the end of the water discharge hose to the dirty water discharge drain, the sink or the bathtub.
- ▶ Place the power cable and hoses in locations without risk of tripping.
- ▶ Do not install the product behind a door, a sliding door or at another location that will prevent the door from opening completely.
- ▶ If a drier is to be placed on the product, fix with a suitable connection apparatus obtained from the authorized service.
- ▶ There is a risk of contact with electrical pieces when the upper trays is removed. Do not dismantle the upper tray of the product.
- ▶ Place the product at least 1 cm away from the edges of furniture.

& 1.6 Usage Safety

- ▶ Only detergents, softeners and additives suitable for washing machines should be used.
- ▶ Never use any chemical solvents in the product. These materials have the risk of explosion.
- ▶ Do not operate defective or damaged products. Unplug the product (or turn off the fuse it is connected to), turn off the water tap and call an authorized service.

- ▶ Do not place sources of ignition (burning candle, cigarettes, etc.) or sources of heat (irons, furnaces, ovens, etc.) on top of or near the product. Do not put inflammable/explosive materials near the product.
- ▶ Do not stand on top of the product.
- ▶ Unplug the product and turn off the tap if you will not be using the product for long periods.
- ▶ Detergent/maintenance materials may splash out of the detergent drawer if it is opened while the machine is working. Contact of the detergent with your skin and eyes is dangerous.
- ▶ Make sure pets do not climb inside the product. Check inside the product before use.
- ▶ Do not force open the locked loading door. The door will open once the washing is completed. If the door does not open, use the solutions for "loading door does not open" error in the Troubleshooting section.
- ▶ Do not wash elements contaminated with gasoline, kerosene, benzene, reducers, alcohol or other inflammable or explosive materials and industrial chemicals.
- ▶ Do not directly use dry cleaning detergent and do not wash, rinse or spin laundry contaminated with dry cleaning detergent.
- ▶ Do not place your hands into the rotating drum. Wait until the drum no longer rotates.
- ▶ Do not place your hand or a metal object under the washing machine.
- ▶ If washing laundry at high temperatures, the discharged washing water would burn your skin if in contact with your skin, for ex. When the discharge hose is connected to the tap. Do not touch the discharge water.
- ▶ Take the following precautions to prevent formation of biofilm and malodors:
 - Make sure the room where the washing machine is placed is well ventilated.
 - Wipe the bellows and loading door glass with a dry and clean cloth at the end of the program.
- ▶ The glass of the loading door will heat up when washing at high temperatures. Therefore, do not allow especially children to touch the glass part of the loading door during washing.

& 1.7 Maintenance and cleaning safety

- ▶ Do not wash the product with pressure washers, by spraying vapor, water or pouring water.
- ▶ Do not use sharp and abrasive tools while cleaning the product. Do not use household cleaners, soap, detergent, gas, gasoline, thinner, alcohol, varnished. while cleaning.
- ▶ Cleaning agents containing solvents might reek poisonous fumes, for ex. Cleaning solvent. Do not use cleaning products containing solvents.
- ▶ There may be detergent residues in the detergent drawer when you open it for cleaning.
- ▶ Do not dismantle the filter of the discharge pump while the product is running.
- ▶ The temperature in the machine may rise up to 90°C. Clean the filter after the water in the machine cools down in order to avoid risk of getting burnt.

Important instructions for environment

2.1 Compliance with WEEE Directive

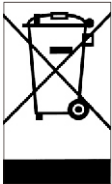

This product complies with EU WEEE Directive(2012/19/EU). This product bears a classification symbol for waste electrical and electronic equipment (WEEE).

This product has been manufactured with high quality parts and materials which can be reused and are suitable for recycling. Do not dispose of the waste product with normal domestic and other wastes at the end of its service life. Take it to the collection center for the recycling of electrical and electronic equipment. Please consult your local authorities to learn about these collection centers.

Compliance with RoHS Directive:

The product you have purchased complies with EU RoHS Directive(2011/65/EU). It does not contain harmful and prohibited materials specified in the Directive.

2.2 Package information

Packaging materials of the product are manufactured from recyclable materials in accordance with our National Environment Regulations. Do not dispose of the packaging materials together with the domestic or other wastes. Take them to the packaging material collection points designated by the local authorities.

WARNING

- This appliance is not intended for use by persons (including children) with reduced physical, sensory or mental capabilities, or lack of experience and knowledge, unless they have been given supervision or instruction concerning use of the appliance by a person responsible for their safety.
- Children should be supervised to ensure that they do not play with the appliance. Cleaning and user maintenance shall not be made by children without supervision. Children of less than 3 years should be kept away unless continuously supervised.
- If the supply cord is damaged, it must be replaced by the manufacturer, its service agent or similarly qualified persons in order to avoid a hazard.
- The new hose-sets supplied with the appliance are to be used and that old hose-sets should not be reused.
- This appliance is intended to be used in household and similar applications such as:
 - staff kitchen areas in shops, offices and other working environments;
 - farm houses;
 - by clients in hotels, motels and other residential type environments;
 - bed and breakfast type environments;
 - areas for communal use in blocks of flats or in launderettes.
- For washing machines having ventilation openings in the base, the openings must not be obstructed by a carpet.
- Manual loss, Call our service number.
- Water pressure: 0.03-1MPa
- **CAUTION:** In order to avoid a hazard due to inadvertent resetting of the thermal cut-out, this appliance must not be supplied through an external switching device such as a timer, or connected to a circuit that is regularly switched on and off by the utility.

Safety Notifications (Please Must Follow)

- In order to prevent the harm or damage to the user or the person and property of others, please make sure to follow the safety issues.

[&Warnings]

- The risk of electric shock.
 1. Please use 220V-240V, above 1QA with ground wire dedicated socket.
 2. When inserting and pulling out the power cord please use the plug, please. Don't use the damaged power cord. When the power cord pin is dirty please wipe clean with dry cloth. in time.
 3. Do not use the wet hand to insert or pull out the plug.
 4. Please pull out the plug when finishing, repairing or cleaning.

- The danger of fire and current leakage
 1. Do not allow the washing machine close to the fire, or lighted cigarettes, candles and volatile materials.
 2. Please do not sprinkle the water on the control panel of the washing machine.
 3. Please do not put the washing machine outside or in a wet place.
 4. Please fix the drain pump and make sure the sewer is unobstructed.

- The danger of high temperature
 1. When washing in high temperatures, the door glass will be heating. Please do not touch the door glass, especially children.
 2. When opening the door after high temperature washing, please wait for the temperature to cool down to a safe level and the door will be unlocked automatically.

- The danger of getting hurt
 1. Please handle the carton box after removing, don't let the children touch or eat.
 2. Do not allow the children to operate or climb up to the washing machine.
 3. Please close the door after use to avoid the children entering the drum.

- The danger of injury
 1. Do not put any heavy things on the top of the washing machine.
 2. If you want to move the machine, please remember to ask for help.
 3. Please do not ask unprofessional people to repair the machine.



- The danger of damage the clothes
 1. Please do not wash the clothes which is waterproof, like Raincoat, feather products, sleeping bags
 2. Please wash the clothes which can be washed, if you have any doubt, please following the instructions.

- The danger of explosion
 1. Please do not wash the cloths which stained with kerosene, gasoline, thinner, inflammable goods.
 2. Please do not wash when there gas leakage.

- When pulling out the plug, the lock can be unlocked even if there is a lot of water inside. So please check the water level inside before unlocking the door in order to avoid the unnecessary loss.

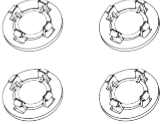

Attachment specification

instruction	water supply hose	wrench	transportation bolt caps
			

Part name

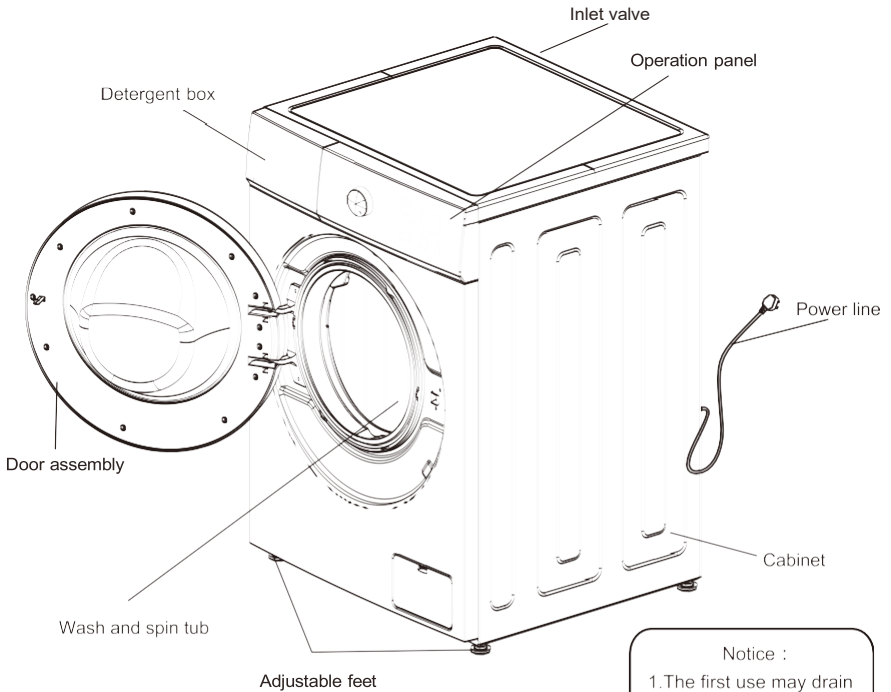

Important notice:

1. The product appearance and specifications may be varied without notice to raise the product quality.
2. The product appearance and specifications may be varied with that of the related energy efficiency test or the related safety test, etc.

Notice :

1. The first use may drain some water out. It's residual water after performance test, belong to the normal phenomenon.
2. After each use, please pull the plug and turn off the faucet to prevent accidental flood or fire.

Installation instruction

- Make sure the temperature of the places where the washer is installed or placed is above 0°C
- Place the washer correctly according to management standards and regulations.
- Keep the base of washer ventilated when it is placed on the ground with carpet.
- Please keep the surroundings clean, any damage caused by cockroaches or other pests will not be covered under warranty.

Transport bolt

Washers are installed with transport bolts to prevent internal damage in transit.

Dismantle the transport bolt

1. In order to prevent internal damage in transit, 4 bolts are installed. Before using the washer, dismantle the bolt (see chart 1).
- If the bolts are not dismantled, violent vibration, noise and trouble will be caused.
2. Use the attached wrench to loosen the 4 bolts (see chart 2).
3. Twist the bolt rubber slightly and then pull out the bolts, keep the bolts and wrench as standby (see chart 3).
- The bolts should be remounted if you need to transport the washer.
4. Use attached stopples to seal the screw holes (see chart 4).

see chart 1



Notice :
dismantle the
drainpipe fixed
device.

see chart 3

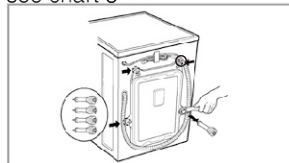

see chart 2

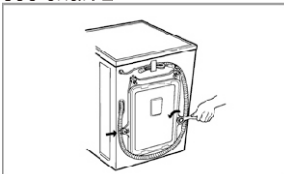

see chart 4

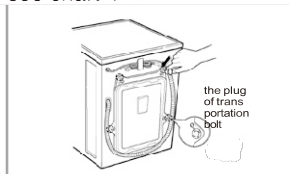

Requires for positions

Horizontal adjustment:

- The slant angle should be less than 1 degree.

Power outlet

- The distance between any side of the washer and power outlet should be within 1.5 meters.
- Don't use too many electrical appliances in one outlet.

Environment cleaning

- It's necessary to clean the wall, door and ground.
- Install the washer on a hard and steady ground with floor drain rather than soft blanket or wooden floor.
- Don't put dirty clothes or some other goods on a washer's head cover, otherwise it may impact the normal operation.

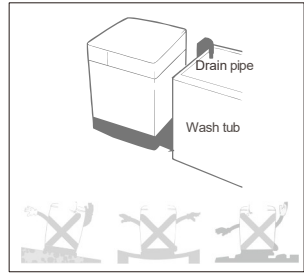

⚠ Notice

Power connection

1. Don't use the wiring board.
 2. If the power lines are damaged, please contact professionals to repair them.
 3. After the use of washer, pull the plug and turn the tap off.
 4. Connect the washer with grounded outlet to correspond to the wiring principles.
 5. Place the washer in which is easy to connect the outlet.
- Contact the maintenance center and ask professionals to repair the washer. Unauthorised engineers may cause damage to the washer.
 - Don't put the washer where the temperature is below zero. The pipes may freeze and break. Moreover, the temperature below zero will damage the programming controller.
 - If moving the washer to an environment where the temperature is below zero, please keep the washer at room temperature for a few hours before starting it.

Grounding introduction

- A washer must have grounding devices. If a fault happens, the device can reduce the risk of electrical shock. The device is equipped with a cable (including a wire and a grounded plug). The grounded plug must be inserted in an appropriate outlet. If you want to know if the washer is grounded correctly, please contact professional maintenance staff. If the plug can't match with the outlet, please don't change the plug by yourself.
- Once your washer smokes or emits an odor, please turn off the power and contact with professional maintenance staff.

Washers should be connected to water inlet. Please use the attached new plumbing rather than the old.

To ensure the quality, water injection tests are carried out before the washer leaves the factory, so there may be water inside the internal tub, door seals and door panel, which are normal.

Water inlet connection

1. The pressure of supply water should be between 30kPa and 1000kPa.
2. Don't abrade the screw thread when connect the inlet pipes with valves.
3. Please install dropping equipment if the pressure of supply water surpasses 1000kPa.
 - Two seals are supplied in the connectors of both ends of the pipe to prevent water leaking.
 - Turn on the tap and check if the connectors leak.
 - Check the pipes regularly. Please change them if necessary.
 - Make sure the pipes are not damaged or twine with each other.

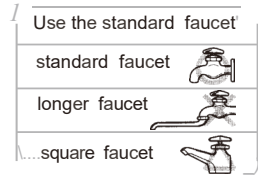

The connection of inlet pipes and taps

- 1** Check the rubber seals on both sides of the hose.
 - insert a rubber seal into the threaded fittings on each hose to prevent leaking.
- 2** Connect the water supply hoses to the water faucets tightly by hand and then tighten another 2/3 turn with pliers.
 - Connect the blue hose to the water faucet.

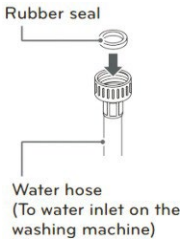

⚠ WARNING

- Do not overtighten. Damage to the coupling can result.

- 3** After connecting inlet hose to water faucets, turn on the water faucets to flush out foreign substances (dirt, sand or sawdust) in the water lines. Let water drain into a bucket, and check the water temperature.
- 4** Connect the hoses to the water inlet tightly by hand and then tighten another 2/3 turn with pliers.

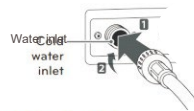

⚠ WARNING

- Do not overtighten the hoses. Overtightening can damage the valves resulting in leaking and property damage.

- 5** Check for leaks by turning on the faucets. If water leaks, check steps 1 to 4 again.

- This washing machine is designed for home appliances, please do not install it on ship, traveling truck or plane.
- Please turn off the stopcock if long time out of use. (e.g. Vacation)
- Please remove the plug and cancel door lock function to avoid child locking himself/herself inside.
- Packing materials (e.g film, foam) could harm a child's safety and cause asphyxia! Attention: MAKE ALL PACKING MATERIEALS OUT OF CHILD REACH.

Install drainpipe

- Please fix the drainpipe with a lifting rope.
- For the sake of lightening damage of leak towards ground, please place the drainpipe correctly.
- To avoid siphon, the height of drainpipe should be between (0.85m-1.25m), moreover, the terminal of this should not be placed in water.
- If the drainpipe is too long, please do not force to insert it into washing machine, which would cause abnormal noise. (Please check sketch map next page)

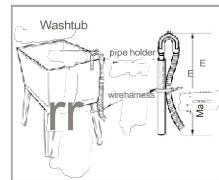
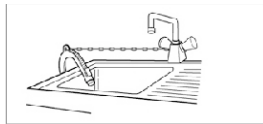
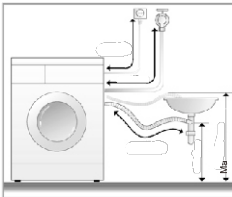

The instruction of installation of pipe

Horizontal Adjustment

- To avoid noise and vibration adjust washing machine level. Ideally place it in the corner of the room.
- If the ground is not level, please adjust the alignment pins. Do not use wood pieces or similar, please make sure four alignment pins touch ground tightly, and machine is completely level.



- Adjust adjustable feet

Adjust the adjustable feet to make sure the washing machine is in balance, which can be placed on the ground steadily. After settling, screw the locknut to guarantee. Do not place the washing machine in the platform, which is higher than the ground, in order to prevent the machine from falling down because of other accidents.

- The diagonal check

Applying force downward on the diagonal of the washing machine, washing machine should not shake. (Both diagonal need to check, if the washing machine shake, must readjust adjustable foot.)

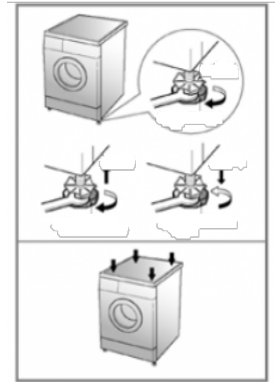

Methods of Door Lock and Remove

DOOR LOCK

- After operating, the door will be locked automatically and "DOOR LOCK" light/picture on the panel is lighting.

Remove Door Lock

- When "DOOR LOCK" light/picture is lighting. Press "Start/pause", WASHING/DEWATERING drum stop operating. Please wait for about 2 minutes. Door lock will be removed automatically.
- Foam overflowing if the door is opened during operation, please catch foam with a towel.
- If the temperature is too high, the door cannot be opened during operation.
- If water level is too high, the door can not be open during operating.



Synthetic Detergent Powder 

- Please dissolve detergent (e.g soap pieces) before putting into detergent box.

Liquid detergent. Bleach 

- Please use detergent with less foam.
- Please use two times water to dilute the concentrated type detergent before putting into detergent box.

Softener 

- Please put softener before washing, which will pour into drum automatically when last patch happening.
- When using concentrated type softener, please dilute it with appropriate water.
- Do not exceed MAX mark.

Prewashing Detergent 

- Please put moderate detergent after selecting Pre-washing function if cloths is too dirty.

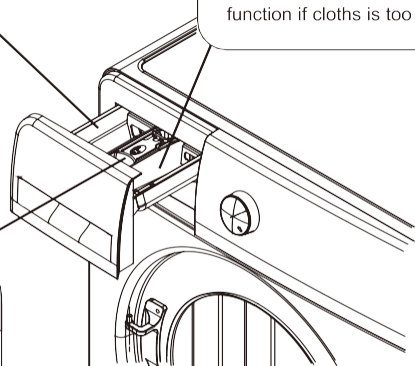

- Use special detergent.
- Do not use too much detergent which will cause too much foam and affect washing quality or will cause malfunction.
- Select detergent according to cloths variety, color, water temperature and contamination level.
- Please use moderate detergent to get washing effect and protect environment.

The Recommendations on detergent use at the various temperatures

- When washing heavily soiled whites, we recommend using cotton programs of 60°(or above and a normal washing powder(heavy duty) that contains bleaching agents that at medium/high temperatures provide excellent results.
- For washes between 40°(and 60°(,the type of detergent used needs to be appropriate for the type of fabric and level of soiling. Normal powders are suitable for "white" or color fast fabrics with high soiling, while liquid detergents or "color protecting" powders are suitable for colored fabrics with light levels of soiling.
- For washing at temperatures below 40°(we recommend the use of liquid detergents or detergents specifically labeled as suitable for low temperature washing.

Function Introduction of Operating Panel

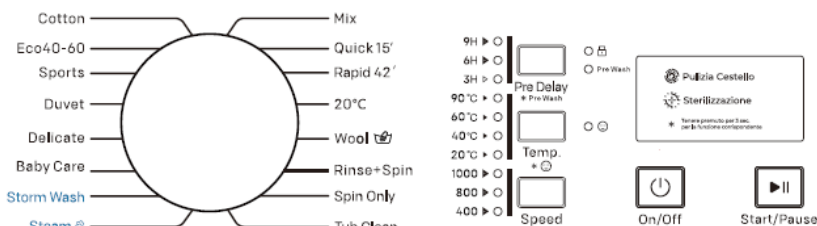

Image shown here is indicative only. Actual product you receive may differ.

1. On/Off Button

- Turn power ON/OFF.
- When procedure finish, press On/Off to cut off power.

2. Start/Pause Button

- Press it to start operating
- Press it to pause during operation, press again to continue.

3. Pre Delay Button

When use "Pre Delay" function for washing, the delay time is 3hours, 6hours, 9hours, 12hours, 15hours, 18hours.

- If want to cancel the Pre Delay function, push one cycle of "Pre Delay" button.
- The Pre Delay time means from wash start to wash ending time.
- You should operate the Pre Delay function after selecting the program and before push the button of "start/pause".

4. Pre Wash Lamp

- If the cloths are too dirty, you can choose this program before washing.
- Press "Pre Delay" for more than 3 seconds to On/Off Pre Wash function.

5. "Temp." Button

- When push the power button to start the machine and select the program, you can choose proper water temperature according to the material of cloths.

6. Child-Lock Lamp e>

- Press it to guard against child operating.
- Child-Lock operating, other buttons unavailable except " On/Off".
- Press "Temp." for more than 3 Seconds to ON/OFF Child Lock function.

7. Speed Button

- When push the power button to start the machine and select the program, you can choose different spin speed.

8. Program Knob

- Select a program according to variety and contamination of clothes.

9. Status Indicator

- EI Door Lock: This icon indicates the condition of opening and closing of the door lock.
- CJ Child Lock: icon on the upper left is used to control the opening and closing of the child lock. The right side displays the condition of closing of the child lock.

The introduction of function and program

Usage of routine clothes

1. Preparations

- Open the door, put clothes in and close the door.
- Pull out the detergent box, add detergent and close the box.
- Connect the inlet pipes and make sure the tap turned on.

2. Press the on/Off button

3. The programs can be selected according to requirements.

4. Press Start/Pause button and begin to wash

5. When all operations are finished, the buzzer emits a noise.

- Open the door to get clothes out.
- Unplug and turn off the stopcock.

Cotton Program Introduction

This program is suitable for clothes which are moderate or mildly dirty, like cotton, beddings, underwear, towels and shirt, etc...

Sports Program Introduction

Used for washing sports clothes, can wash the sweat and dirt on the clothes

Duvet Program Introduction

Used for washing heavy clothes, such as coats, big towels and so on

Delicate Program Introduction

Washing gauze, silk clothes.

Baby Care Program Introduction

Used for washing baby clothes to make clothes cleaner.

Storm Wash Program Introduction

Storm wash reduces laundry process by increasing beat frequency, reducing dwell time, which shortens the laundry time by about 30%, making the most of efficiency utilization.

Steam Program

The steam function is activated to have the inner drum environment heated, leading to the improvement on washing performance and dirt reduced.

Mix Program Introduction

This function can be used to wash mixed clothes like cotton, synthetic and so on (please do not mix wash the clothes that easily rub off.)

Quick 15' Program Introduction

To wash clothes that are changed frequently, not too dirty and thin clothes

Rapid 42' Program

To wash clothes that are changed frequently, not too dirty and thin clothes

20°C

Wash minor stains

Wool Program Introduction

For washing wool fabrics marked "machine washable"

Rinse + Spin Program Introduction

The machine will not wash, only rinse and spin.

Spin Only Program

The machine will not wash and rinse, only spin.

Tub Clean Program Introduction

Clean the inside bucket of the washing machine briefly. Please do not put clothes in it.



Function	Description	
Child lock	Statement	In order to avoid child misplay
	Setup to remove	During operation, press Temp. for more than 3 seconds, please unplug and or press Temp. to remove Child Lock
intellectual lock-remove	Statement	When operation is over, if water inside is higher, the drain water pump is be on to drain to the open lock water level and stop.
Compensation of power-off	Statement	When power is connected after power off, the time point will continue from the previous stop time point.
Door self-lock	Statement	After selecting procedure, the door locked automatically, 2 minutes after operation over, lock removed.
Clearance of the drum	Statement	To remove wasted and germ, please sterilize to clean the drum.

	Temperature		
Cotton	40(cold,20,60,90)	800(0,400,1000)	75
Eco40-60	40(cold,20,60)	1000(0,400,800)	135
Sports	cold (20,40)	800(0,400)	44
Duvet	40(cold,20,60)	800(0,400,1000)	88
Delicate	20(cold,40)	800(0,400)	48
Baby Care	60(40,90)	800(0,400,1000)	142
Storm Wash	20(cold,40,60)	800(0,400,1000)	39
Steam	60(cold,20,40,90)	800(0,400,1000)	165
Mix	cold (20,40)	800(0,400)	76
Quick 15'	cold (20,40)	800(0,400)	15
Rapid 42'	40(cold,20)	800(0,400)	42
20'	20	1000(0,400,800)	63
Wool	40(cold/20)	800(0,400)	47
Rinse + Spin		800(0,400,1000)	16
Spin Only		800(0,400,1000)	10
Tub Clean	60(90)	800	75

- Remarks:

- The time consumption will be changed according to the water pressure, cloths variety, quantity, water temperature.
 - The difference between displayed on screen and actual time consumption will happen.
 - If speed is too lower, poor washing effect will happen, please add more rinse time.
 - Different parameters, different models.
 - When self-designed default procedure is energy procedure, the washing time will be increased automatically.
- The eco 40-60 program is able to clean normally soiled cotton laundry declared to be washable at 40 °C or 60 °C, together in the same cycle, and that this program is used to assess the compliance with the EU eco-design legislation.
 - The most efficient programs in terms of energy consumption are generally those that perform at lower temperatures and longer duration.
 - The household washing machine or the household washer-dryer up to the capacity indicated by the manufacturer for the respective programs will contribute to energy and water savings.
 - Noise and remaining moisture content are influenced by the spinning speed: the higher the spinning speed in the spinning phase, the higher the noise and the lower the remaining moisture content
 - You can find the model information stored in the product database, as defined in Regulation (EU) 2019/2014 by means of a weblink that links to the model information as stored in the product database or a link to the product database and information on how to find the model identifier on the product below.
 - You can Check the manual and the QR code on the energy efficiency label

- Please maintenance washing machine to extend service life.
- Before maintenance, please unplug.

Body of washing machine

After washing, please clean it with soft cloth. If much contamination, please use appropriate detergent or soap.

- Do not watering directly.
- Do not use putty-powder, diluent, gasoline, alcohol to clean machine body.

The Clearance of Detergent Box

Please clean the detergent box regularly. Pull it out and wash with clean water, then insert back.

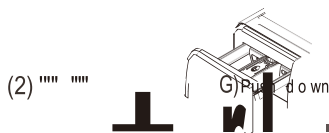

Door Gasket Ring

After washing, please remove contamination, wastepaper and so on, if foreign matter exists, please remove.

The Clearance of Universal coupling (Suggest:Once/ half year)

- If waste accumulated, it would influence water inlet speed.
1. Take off the soft pipe from the connecting part side.
 2. Take off the screwing device according to the arrow showed.
 3. Wash the inside of the screwing device.
 4. install the cleaned crewing device with the inlet soft pipe.



The clearance of inlet water valve (Suggest: Once/ half year)

1. Take off the soft pipe from washing machine side.
2. Take off the filter net from water valve.
3. Clean the filter net with tooth brush.
4. install the soft inlet pipe.

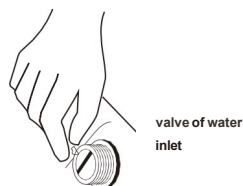

Maintenance

When washing machine is frozen

1. Cover the stopcock and connecting part with hot towel.
2. Take off the inlet pipe and put it into 50-degree water.
3. Pour into the drum about 2-3L of 50-degree water.
4. Connect inlet pipe, turn on the stopcock and start the washing machine, please check whether inlet and outlet are normal.

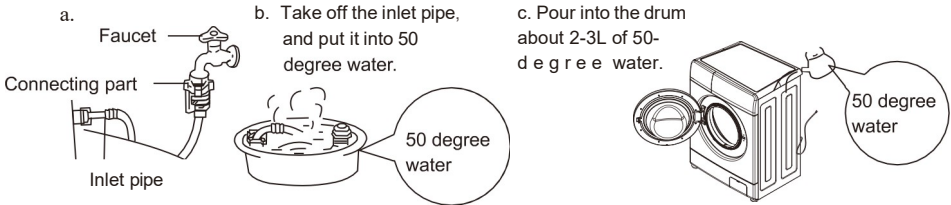

The Clearance of dewatering-pump filter (Suggest: once/month)

1. Press fastener on the pump after dewatering and powering off, open the lid of water-pump filter. (Attention: if hot water is inside, please go ahead after it gets cold.)
2. Take off the filter anti-anticlockwise.
3. Wash the filter.
4. Direct at pump and insert the filter, tighten it clockwise and tighten the lid.
Attention: a. Please tighten the filter well to avoid leaking.
b. Please do not clean during operation.

The Drum Clearance (Suggest once/month)

After using for a period, some dirt maybe exists. You can clean the inside and outside of the drum by operating the drum procedure.

Attention: please do not put cloths and detergent on when clearing the drum.

Notice before Washing

1. Washing guide identification

- Please check clothes washing guide identification, which shows clothes texture and washing method.

2. Classification washing

- Please wash clothes of the same texture, different texture, different water temperature, speed and washing procedure, please split deep colored cloths from white cloths. Split dyed cloths from cotton, otherwise the white cloths would be discolored. If possible, please do not wash high contaminated clothes with clean ones together.
- The degree of pollution (serious, moderate, slight) classify clothes and wash according to the degree.
- color (white, light color, deep color) classify them and wash.
- velveteen (easy to fall off, easy to be adhered) classify the white and the deep color.

3. Notes

- When putting big and small clothes together, put the big first and they must be less than half of total clothes. Please don't wash single cloth because it may cause imbalance. Please add one or two similar clothes.
- Small clothes like underwear and socks should be put into a mesh bag to wash. Before washing bras with steel rings, please take the rings out. If it is inconvenient to do this, please put them into mesh bags to prevent the bra slipping into the gap between internal and external tubs.
- Check all pockets and make sure nothing is in them. Nails, hairpin, match, pen, coin and key will damage your washer and clothes.
- Zip up all clothes, fix the button and hook and tie the loose belt, make sure that other clothes cannot be damaged by them.
- Firstly, use water with a little detergent to wash the parts with too many stains, such as collar and cuffs, which can make the clothes cleaner.

- Check the door seals and make sure there is nothing on them.
- Make sure there is nothing in the tub before washing.
- Please use the low bubble detergent specially for front loading washing to wash the cloths.

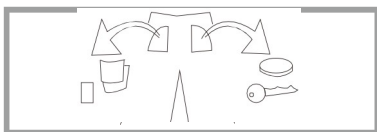
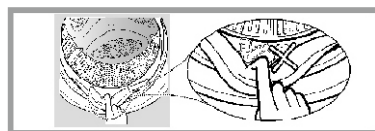
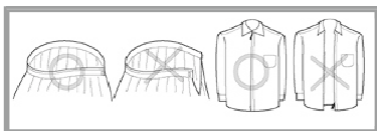
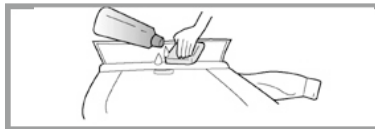
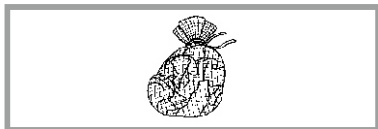



The door can't open.	<ul style="list-style-type: none">• The program is running.• There are clothes between the door and door seals.
There is an odor.	There may be a smell of rubber because some components are made up of rubber.
There is too little water when wash and rinse.	<ul style="list-style-type: none">• Roller washing machines just need a little water when operating.
No water inflowing.	<ul style="list-style-type: none">• Is the tap turned on?• Is the inlet pipe frozen?• Are the filters blocked?
Water inflows halfway	<ul style="list-style-type: none">• If the water level declines, the washer will supply water automatically.
Water outflows when washing.	Check if add the detergent with too many bubbles.
Remaining time changes	<ul style="list-style-type: none">• If clothes are off center when spinning, spinning time will extend to correct the deviation.
There is abnormal noise when spinning.	<ul style="list-style-type: none">• Check if the power line touches the cabinet.• Have the transport bolts been dismantled?• Are there some hairpins or coins in the roller?
The washer can't work after the failure of electricity.	<ul style="list-style-type: none">• The washer will stop working after the failure of electricity. When the power is restored, it still can't continue to work. Please press the power button and reset the program.



Phenomenon	Indicator light state				check points	solutions
	Child Lock	3H	6H	9H		
Water inflow	flash	light	quench	quench	<ul style="list-style-type: none"> • Check if turn the tap off? • Is the water supply cut off or the water pressure too low. • Are the water inlet pipes frozen? • Are the filters blocked? 	<p>Open the stopcock. Please wait.</p> <p>Use hot water to unfreeze the pipes. Take out the filters and clean them.</p>
Water outflow	flash	quench	light	quench	<ul style="list-style-type: none"> • Are the outlet pipes placed too high? • Are the outlet pipes frozen? • Are the outlet pipes blocked? • Are the floor drain blocked? 	<p>Please put away the outlet pipes and make sure the height is within 1M. Use hot water to unfreeze the pipes. Take out the foreign matter and dredge the pipes. Clean the floor drain.</p>
Door trouble	flash	quench	quench	light	<ul style="list-style-type: none"> • Make sure the washer did not start without the door being closed fully 	<p>Make sure the door truly closed</p>
Spin trouble	flash	light	quench	light	<ul style="list-style-type: none"> • Check if disassemble the carriage bolt? • Is the machine placed steadily? • Are the clothes too small or light? • Are the locknuts on under the feet tightened up? 	<p>Disassemble the carriage bolt. Place the machine on a steady ground. Add more clothes. Tighten up the locknuts.</p>
Continuous water	flash	light	light	quench	<p>Close the stopcock, pull the plug and contact the after-sales service.</p>	
when wash tub doesn't rotate.	flash	quench	quench	quench	<p>Close the stopcock, pull the plug and contact the after-sales service.</p>	
Too much foam					<ul style="list-style-type: none"> • Check if add too much detergent? 	<p>Add reasonable amount of detergent. Use the detergent correctly.</p>

Specification

Rated washing capacity	6.0kg
Rated spinning capacity	6.0kg
Rated voltage	220-240V "±", 50Hz
Rated washing power	250W
Rated spinning power	400W
Rated heating power	1500W
Maximum power	1750W
External dimension	595*440*850mm

Specification. Picture and feature are subject to change without prior notice for purpose of product improvement.



Supplier's name or trade mark: Powerpoint

Supplier's address (1): 9 Western Ind Est Dublin 12

Model identifier: P35106SKS2WA

General product parameters:

Parameter	Value		Parameter	Value	
Rated capacity (1) (kg)	6.0		Dimensions in cm	Height	85
				Width	60
				Depth	44
EElw(1)	52.0		Energy efficiency class (1)	A	
Washing efficiency index (1)	1.031		Rinsing effectiveness (g/kg) (1)	5.0	
Energy consumption in kWh per cycle, based on the eco 40-60 programme. Actual energy consumption will depend on how the appliance is used.	0.421		Water consumption in litre per cycle, based on the eco 40-60 programme. Actual water consumption will depend on how the appliance is used and on the hardness of the water.	36	
Maximum temperature inside the treated textile (1) (°C)	Rated capacity	30	Remaining moisture content (1) (%)	62.9	
	Half	24			
	Quarter	21			
Spin speed (1) (rpm)	Rated capacity	1000	Spin-drying efficiency class (1)	C	
	Half	1000			
	Quarter	1000			
Programme duration(1) (h:min)	Rated capacity	3:18	Type	free-standing	
	Half	2:36			
	Quarter	2:36			
Airborne acoustical noise emissions in the spinning phase (1) (dB(A) re 1 pW)	76		Airborne acoustical noise emission class(1) (spinning phase)	B	
Off-mode (W)	0.50		Standby mode (W)	NIA	
Delay start (W) (if applicable)	4.00		Networked standby (W) (if applicable)	NIA	

Minimum duration of the guarantee offered by the supplier(1):

This product has been designed to release silver ions during the washing cycle

NO

Additional information:

Web link to the supplier's website, where the information in point 9 of Annex II to Commission Regulation (EU) 2019/2023 (1) (b) is found:

(1) for the eco 40-60 programme.

(b) changes to these items shall not be considered relevant for the purposes of paragraph 4 of Article 4 of Regulation (EU) 2017/1369.

(j) if the product database automatically generates the definitive content of this cell the supplier shall not enter these data.

Information to be included in the technical documentation for household washing machines

PARAMETER	UNIT	VALUE
Rated capacity for the eco 40-60 programme, at 0,5 kg intervals (c)	kg	6.0
Energy consumption of the eco 40-60 programme at rated capacity ($E_{w,ru(1)}$)	kWh/cycle	0.605
Energy consumption of the eco 40-60 programme at half rated capacity ($E_{w,1/2}$)	kWh/cycle	0.320
Energy consumption of the eco 40-60 programme at quarter rated capacity ($E_{w,1/4}$)	kWh/cycle	0.205
Weighted energy consumption of the eco 40-60 programme (E_w)	kWh/cycle	0.421
Standard energy consumption of the eco 40-60 programme (SCE_w)	kWh/cycle	0.810
Energy Efficiency Index (EEI _w)		52.0
Water consumption of the eco 40-60 programme at rated capacity ($W_{w,ru(1)}$)	L/cycle	40.0
Water consumption of the eco 40-60 programme at half rated capacity ($W_{w,J}$)	L/cycle	35.0
Water consumption of the eco 40-60 programme at quarter rated capacity ($W_{w,1/4}$)	L/cycle	30.0
Weighted water consumption (W_w)	L/cycle	36
Washing efficiency index of the eco 40-60 programme at rated capacity (I_{*})		1.031
Washing efficiency index of the eco 40-60 programme at half rated capacity (I_w)		1.031
Washing efficiency index of the eco 40-60 programme at quarter rated capacity (I_w)		1.031
Rinsing effectiveness of the eco 40-60 programme at rated capacity (I_{*})	g/kg	5.0
Rinsing effectiveness of the eco 40-60 programme at half rated capacity (I_R)	g/kg	5.0
Rinsing effectiveness of the eco 40-60 programme at quarter rated capacity (I_{*})	g/kg	5.0
Programme duration of the eco 40-60 programme at rated capacity (c_w)	h:min	3:18
Programme duration of the eco 40-60 programme at half rated capacity (t_w)	h:min	2:36
Programme duration of the eco 40-60 programme at quarter rated capacity (c_w)	h:min	2:36
Temperature reached for minimum 5 min inside the load during eco 40-60 programme at rated capacity (T)	°C	30
Temperature reached for minimum 5 min inside the load during eco 40-60 programme at half rated capacity (T)	°C	24
Temperature reached for minimum 5 min inside the load during eco 40-60 programme at quarter rated capacity (T)	°C	21
Spin speed in the spinning phase of the eco 40-60 programme at rated capacity (S)	rpm	1000
Spin speed in the spinning phase of the eco 40-60 programme at half rated capacity (S)	rpm	1000
Spin speed in the spinning phase of the eco 40-60 programme at quarter rated capacity (S)	rpm	
Weighted remaining moisture content (D)	%	62.9
Airborne acoustical noise emissions during eco 40-60 programme (spinning phase)	dB(A) re 1 pW	76
Power consumption in 'off mode' (P ₀)	W	0.50
Power consumption in 'standby mode' (P _m)	W	N/A
Does 'standby mode' include the display of information?		NO
Power consumption in 'standby mode' (P _m) in condition of networked standby (if applicable)	W	N/A
Power consumption in 'delay start' (P _d) (if applicable)	W	4.00

Health & Safety

Location

- This appliance is intended to be used in household and residential type environments. It is not suitable for use in shops, offices and other working environments
- Do not use outdoors or in a bathroom
- Do not place appliance on a highly polished wooden surface as damage may occur to the surface
- Do not place the appliance on or near a hot surface
- This appliance should not be used in an unheated, cold room i.e. Garage, conservatory, annex, shed, out-house etc.

Mains Cable

- Do not let the lead run across an open space
- Do not let the cable run across a cooker or hot area which may damage the cable
- The mains cable should reach from the socket to the base unit without straining the connections
- The power cord cannot be replaced

Personal Safety

- Do not touch discharging hose or water as they may reach high temperatures and risk burning
- To protect against the risk of electric shock ensure the electrical connections are kept dry
- This appliance is not intended for use by persons (including children) with reduced physical, sensory or mental capabilities

Children

- Children should be supervised to ensure that they do not play with this appliance
- Teach children to be aware of dangers in the kitchen
- Do not allow children to play with the appliance or tamper with the controls
- Children under the age of 8 should not use this appliance

Other Safety Considerations

- Do not operate any appliance with a damaged cord or plug or after the appliance malfunctions or has been damaged in any manner
- Do not use the appliance for anything other than its intended purpose
- Unplug from the outlet when not in use or unattended and before assembling, disassembling and cleaning
- Make sure the appliance is switched off before connecting to or disconnecting from the mains supply
- If the appliance is dropped or damaged in any manner, return the appliance to the nearest authorized dealer or after-sales service centre for examination, repair, electrical or mechanical adjustment

POWERPOINT STANDARD MANUFACTURER WARRANTY

TERMS AND CONDITIONS

This appliance was supplied by Shomar Ltd, Dublin. Combining years of knowledge and experience with our commitment to producing high quality appliances is what make us the country's best, fully Irish owned, Domestic Appliance Distributor. We provide all after sales services from our Headquarters in Dublin.

12 Month Warranty

This Warranty is for 12 Months from Date of Purchase and covers both Parts & Labour. Any complaints that occur during normal use of these appliances will be repaired free of charge provided the appliance has been used and maintained in accordance with the Terms and Conditions.

If a repair to your appliance is necessary, evidence of purchase will be required for a call to be covered by your Warranty.

Two-year Warranty

To avail of the second-year free warranty, you must register your new appliance with Shomar Ltd. Registering your appliance will also allow us to contact you in the unlikely event that a modification is required. In case of an insurance loss such as theft, fire or flood, your registration will serve as proof of purchase. Scan our QR to register your warranty -



P351065KS2WA

Terms and Conditions

The Warranty only covers the appliance for use in a normal domestic environment. Institutional use or commercial use is not covered. (To obtain a commercial Warranty on your appliance contact us on service@shomar.ie for more details)

The following is not covered by the Warranty:

- Complaints due to the use of incorrect voltage.
- Failure of the water supply
- Failure of the electricity supply
- Failure to operate the appliance in line with the guidelines set out in the instruction manual.
- Damage to the appliance or its components however caused.
- Consumable items. E.g. Fuses, bulbs, broken glass, Knobs, Plastics.
- Blockages of Filters, drainage systems, soap dispensers etc

Note:

- Repairs or modifications carried out by anyone other than Shomar authorised agents will deem the Warranty Null and Void. Please visit www.Thorappliances.ie to obtain information on authorised agents.

- All Gas appliances must by law be fitted by a Registered Gas Installer. For further details see WWW.RGI.IE

- Built In appliance installation and reversing the door hinges must be undertaken by a competent person.

- If in any doubt about the installation of our domestic appliances please email us for more details service@shomar.ie

How to log a service call:

If in the event you need to log a service call for your appliance you can contact our service department on Ph: 01-4505327 (during working hours)

Email service@shomar.ie

Go online www.powerpointappliances.ie

This Warranty does not in any way diminish or affect your statutory rights in connection with the product. This Warranty is in addition to your statutory rights as a consumer. If you have any questions about these rights, please contact the retailer from which you purchased the product. In certain circumstances, it is possible that your statutory rights may offer additional or higher levels of protection than those offered under the terms of this Warranty.

This Warranty applies only to the cost of repairing the product. To the extent permitted by law, the Manufacturer does not accept and will not be held liable for any financial loss incurred in connection with the failure of any product to operate in accordance with the expected standards. Such financial loss includes but is not limited to loss arising from:

- Food Loss
- Time taken from work
- Damaged clothing or other items
- Laundry costs
- Meals from Restaurant /Takeaways
- General Compensation for Inconvenience

Does Powerpoint offer replacements?

This is a repair-only Warranty. On occasion, the Manufacturer may at its sole discretion, replace your product with a new product instead of carrying out a repair. In the unlikely event we cannot repair your appliance it will be replaced free of charge, replacement will be authorised and provided by the retailer upon contact with the manufacturer. Any costs related to disconnecting the faulty product and installing the replacement product will not be borne by the Manufacturer unless previously agreed to in writing. The original Warranty will continue to apply to the replacement product; the new product will not come with a new Warranty.

Will I be charged for the repairs?

It is the responsibility of the consumer to provide proof of purchase to the Engineer to ensure your product is covered by this warranty. The Manufacturer reserves the right to

charge for service call if:

- You cannot provide proof of purchase that your product is covered by this Warranty.
- The engineer finds that there is no fault with your product.
- That your product has not been installed or operated in accordance with the User Manual.
- That the fault was caused by something other than faulty materials, defective components, or manufacturing defects.
- For missed appointments.

Payment is due immediately upon the Engineer providing you with an invoice. The Manufacturer reserves the right to terminate the Warranty if you fail to pay the costs for the service call.

The spare part availability of this appliance is 10 years. During this time, original spare parts will be available to operate the appliance properly.

This appliance was supplied by Shomar Ltd Dublin. If you would like to contact us in relation to your product for service or spare parts we can be contacted on 01-4505327 or service@shomar.ie.

The model information as stored in the product database can be reached by scanning the QR Code below or by visiting <https://eprel.ec.europa.eu/> and entering the following number: P35106SKS2WA