



PowerPoint

6 kg Washing Machine

P35106SKW-A
P35106SYIN-A

7 kg Washing Machine

P35147SKW-A

8 kg Washing Machine

P35148SKW-A
P35148SSYIN-A

9 kg Washing Machine

P35149SKW-A

10 kg Washing Machine

P351410SKW-A
P351410SYIN-A

INSTRUCTIONS:

Please read and keep safe for future use.

Please read these instructions first before using your appliance

Please take some time to read this user manual before using your appliance, to ensure you know how to safely operate the controls and functions.

Carefully follow unpacking and installation instructions to ensure the appliance is correctly connected and fitted prior to use.

General safety instructions

This section contains safety instructions that will help protect from risk of personal injury or property damage.

Our company shall not be liable for any damages that may arise in case of failure to follow these instructions.

- ▶ Always have the installation and repairing procedures carried out by the Authorised Service Agent.
- ▶ Only use original spare parts and accessories.
- ▶ Unless explicitly stated in the user's manual, do not repair or replace any part of any product.
- ▶ Do not make technical modifications in the product.

& 1.1 Intended Purpose

- ▶ This product is designed to be used in indoor areas, homes and similar locations. For example;
 - Personnel kitchens of stores, offices and other work environments;
 - Farmhouses;
 - By customers of hotels, motels and other accommodation facilities
 - Bed and breakfasts, hostel-like environments
 - Common areas of apartment blocks or laundries

Use the product only for washing textiles with a machine-washable label attached by the manufacturer. The product is not intended for commercial use.

&1.2 Safety of children, vulnerable persons and pets

- ▶ This product can be used by children at and above 8 years old and by persons whose physical, sensory or mental capabilities were not fully developed or who lack experience and knowledge provided that they are supervised or trained on the safe usage of the product and the risks it brings out.
- ▶ Children under the age of 3 should be kept away unless continuously supervised.
- ▶ Electrical products are dangerous for the children. Children or pets should not play with, climb on top or inside the product. Check inside the product before use.
- ▶ Use child lock to prevent children from intervening with the product.
- ▶ Do not forget to close the loading door when leaving the room where the product is located. Children and pets may get locked inside and drown.
- ▶ Children should not perform cleaning and user maintenance works without an adult's supervision.
- ▶ Keep packaging materials away from children. Danger of injury and drowning.
- ▶ Keep all detergents and additives used for the product away from children's reach.
- ▶ Cut the power cable and break and deactivate the locking mechanism of the loading door before disposing of the product for children's safety.

1.3 Electrical safety

- ▶ Product should be unplugged during installation, maintenance, cleaning and repair procedures.
- ▶ If the power cable is damaged, it must be replaced by the authorized service in order to avoid possible risks.
- ▶ Do not tuck the power cable under and behind the product. Do not place heavy objects on the power cable. Do not over bend, crush and touch the power cable to sources of heat.
- ▶ Do not use extension cables, multi sockets or adaptors for powering the

product.

- ▶ The plug should be easily accessible. If this is not possible, follow the electricity regulations of the electrical wiring the product is connected to, and there should be a mechanism (fuse, switch, contact breaker, etc.) to separate all poles from the mains.
- ▶ Do not touch the plug with wet hands.
- ▶ Unplug the appliance by holding and pulling the plug, not its cord.
- ▶ Make sure the plug is not wet, dirty or dusty.

& 1.4 Moving Safety

- ▶ Unplug the product before moving, remove the water outlet and water main connections. Drain any water left inside the product.
- ▶ The product is heavy, do not move alone. Do not hold extruding parts such as the laundry loading door to lift and move the product. The upper tray should be tightly fixed for moving.
- ▶ Your product is heavy; it should be carried carefully by two people if a staircase is involved. It may cause injuries if your product falls on you. Do not hit and drop the product while carrying.
- ▶ Carry the product in an upright position.
- ▶ Make sure that the hoses as well as the power cable are not folded, pinched or crushed after the product is fitted into its place after installation or cleaning procedures.

& 1.5 Installation Safety

- ▶ Check the information on the manual and installation instructions to prepare the product for installation and make sure the electrical mains, clean water mains and water outlet are suitable. If not, call a qualified electrician and plumber to have them make the necessary arrangements. These operations are the responsibility of the customer.
- ▶ Check for any damages before installing the product. Do not go ahead with the installation if the product is damaged.
- ▶ Injuries may occur if hands are put into uncovered slots. Close the holes of the transportation safety bolts with plastic plugs.
- ▶ Do not install or leave the product at locations where it may be exposed to external environment conditions.

- ▶ Do not install the product at locations where the temperature drops below 0°C.
- ▶ Do not place the product on a carpet or similar surface. It would create fire hazard since it cannot receive air from underneath.
- ▶ Place the product on a clean, even and hard floor and balance with the adjustable feet.
- ▶ Connect the product to a grounding plug protected by a fuse suitable to the current values on the type label. Make sure the grounding is carried out by an expert electrician. Do not use the product without suitable grounding to local/national regulations.
- ▶ Plug the product in a socket with voltage and frequency values suitable to those indicated on the type label.
- ▶ Do not plug the product in loose, displaced, broken, dirty, oily sockets or sockets with risk of water contact.
- ▶ Use the new hose set provided with the product. Do not re-use old hose sets. Do not make additions to the hoses.
- ▶ Fit the end of the water discharge hose to the dirty water discharge drain, the sink or the bathtub.
- ▶ Place the power cable and hoses in locations without risk of tripping.
- ▶ Do not install the product behind a door, a sliding door or at another location that will prevent the door from opening completely.
- ▶ If a drier is to be placed on the product, fix with a suitable connection apparatus obtained from the authorized service.
- ▶ There is a risk of contact with electrical pieces when the upper trays is removed. Do not dismantle the upper tray of the product.
- ▶ Place the product at least 1 cm away from the edges of furniture.

& 1.6 Usage Safety

- ▶ Only detergents, softeners and additives suitable for washing machines should be used.
- ▶ Never use any chemical solvents in the product. These materials have the risk of explosion.
- ▶ Do not operate defective or damaged products. Unplug the product (or turn off the fuse it is connected to), turn off the water tap and call an authorized service.

- ▶ Do not place sources of ignition (burning candle, cigarettes, etc.) or sources of heat (irons, furnaces, ovens, etc.) on top of or near the product. Do not put inflammable/explosive materials near the product.
- ▶ Do not stand on top of the product.
- ▶ Unplug the product and turn off the tap if you will not be using the product for long periods.
- ▶ Detergent/maintenance materials may splash out of the detergent drawer if it is opened while the machine is working. Contact of the detergent with your skin and eyes is dangerous.
- ▶ Make sure pets do not climb inside the product. Check inside the product before use.
- ▶ Do not force open the locked loading door. The door will open once the washing is completed. If the door does not open, use the solutions for "loading door does not open" error in the Troubleshooting section.
- ▶ Do not wash elements contaminated with gasoline, kerosene, benzene, reducers, alcohol or other inflammable or explosive materials and industrial chemicals.
- ▶ Do not directly use dry cleaning detergent and do not wash, rinse or spin laundry contaminated with dry cleaning detergent.
- ▶ Do not place your hands into the rotating drum. Wait until the drum no longer rotates.
- ▶ Do not place your hand or a metal object under the washing machine.
- ▶ If washing laundry at high temperatures, the discharged washing water would burn your skin if in contact with your skin, for ex. When the discharge hose is connected to the tap. Do not touch the discharge water.
- ▶ Take the following precautions to prevent formation of biofilm and malodors:
 - Make sure the room where the washing machine is placed is well ventilated.
 - Wipe the bellows and loading door glass with a dry and clean cloth at the end of the program.
- ▶ The glass of the loading door will heat up when washing at high temperatures. Therefore, do not allow especially children to touch the glass part of the loading door during washing.

& 1.7 Maintenance and cleaning safety

- ▶ Do not wash the product with pressure washers, by spraying vapor, water or pouring water.
- ▶ Do not use sharp and abrasive tools while cleaning the product. Do not use household cleaners, soap, detergent, gas, gasoline, thinner, alcohol, varnished. while cleaning.
- ▶ Cleaning agents containing solvents might reek poisonous fumes, for ex. Cleaning solvent. Do not use cleaning products containing solvents.
- ▶ There may be detergent residues in the detergent drawer when you open it for cleaning.
- ▶ Do not dismantle the filter of the discharge pump while the product is running.
- ▶ The temperature in the machine may rise up to 90°C. Clean the filter after the water in the machine cools down in order to avoid risk of getting burnt.

Important instructions for environment

2.1 Compliance with WEEE Directive

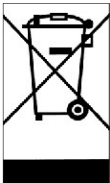

This product complies with EU WEEE Directive(2012/19/EU). This product bears a classification symbol for waste electrical and electronic equipment (WEEE).

This product has been manufactured with high quality parts and materials which can be reused and are suitable for recycling. Do not dispose of the waste product with normal domestic and other wastes at the end of its service life. Take it to the collection center for the recycling of electrical and electronic equipment. Please consult your local authorities to learn about these collection centers.

Compliance with RoHS Directive:

The product you have purchased complies with EU RoHS Directive(2011/65/EU). It does not contain harmful and prohibited materials specified in the Directive.

2.2 Package information

Packaging materials of the product are manufactured from recyclable materials in accordance with our National Environment Regulations. Do not dispose of the packaging materials together with the domestic or other wastes. Take the mto the packaging material collection points designated by the local authorities.

WARNING

- This appliance is not intended for use by persons (including children) with reduced physical, sensory or mental capabilities, or lack of experience and knowledge, unless they have been given supervision or instruction concerning use of the appliance by a person responsible for their safety.
- Children should be supervised to ensure that they do not play with the appliance. Cleaning and user maintenance shall not be made by children without supervision. Children of less than 3 years should be kept away unless continuously supervised.
- If the supply cord is damaged, it must be replaced by the manufacturer, its service agent or similarly qualified persons in order to avoid a hazard.
- The new hose-sets supplied with the appliance are to be used and that old hose-sets should not be reused.
- This appliance is intended to be used in household and similar applications such as:
 - staff kitchen areas in shops, offices and other working environments;
 - farm houses;
 - by clients in hotels, motels and other residential type environments;
 - bed and breakfast type environments;
 - areas for communal use in blocks of flats or in launderettes.
- For washing machines having ventilation openings in the base, the openings must not be obstructed by a carpet.
- Manual loss, Call our service number.
- Water pressure: 0.03-1MPa
- **CAUTION:** In order to avoid a hazard due to inadvertent resetting of the thermal cut-out, this appliance must not be supplied through an external switching device such as a timer, or connected to a circuit that is regularly switched on and off by the utility.

Safety Notifications (Please Must Follow)

- In order to prevent the harm or damage to the user or the person and property of others, please make sure to follow the safety issues.

Warnings

- The risk of electric shock.
 1. Please use 220V-240V, above 1QA with ground wire dedicated socket.
 2. When inserting and pulling out the power cord please use the plug, please. Don't use the damaged power cord. When the power cord pin is dirty please wipe clean with dry cloth. in time.
 3. Do not use the wet hand to insert or pull out the plug.
 4. Please pull out the plug when finishing, repairing or cleaning.

- The danger of fire and current leakage
 1. Do not allow the washing machine close to the fire, or lighted cigarettes, candles and volatile materials.
 2. Please do not sprinkle the water on the control panel of the washing machine.
 3. Please do not put the washing machine outside or in a wet place.
 4. Please fix the drain pump and make sure the sewer is unobstructed.

- The danger of high temperature
 1. When washing in high temperatures, the door glass will be heating. Please do not touch the door glass, especially children.
 2. When opening the door after high temperature washing, please wait for the temperature to cool down to a safe level and the door will be unlocked automatically.

- The danger of getting hurt
 1. Please handle the carton box after removing, don't let the children touch or eat.
 2. Do not allow the children to operate or climb up to the washing machine.. Please close the door after use to avoid the children entering the drum.

- The danger of injury
 1. Do not put any heavy things on the top of the washing machine.
 2. If you want to move the machine, please remember to ask for help.
 3. Please do not ask unprofessional people to repair the machine.



- The danger of damage the clothes
 1. Please do not wash the clothes which is waterproof, like Raincoat, feather products, sleeping bags
 2. Please wash the clothes which can be washed, if you have any doubt, please following the instructions.

- The danger of explosion
 1. Please do not wash the cloths which stained with kerosene, gasoline, thinner, inflammable goods.
 2. Please do not wash when there gas leakage.

- When pulling out the plug, the lock can be unlocked even if there is a lot of water inside. So please check the water level inside before unlocking the door in order to avoid the unnecessary loss.

Part name

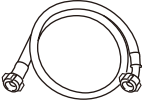
Attachment specification

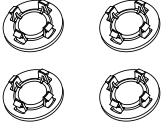
instruction	water supply hose	wrench	transportation bolt caps
			

Part name

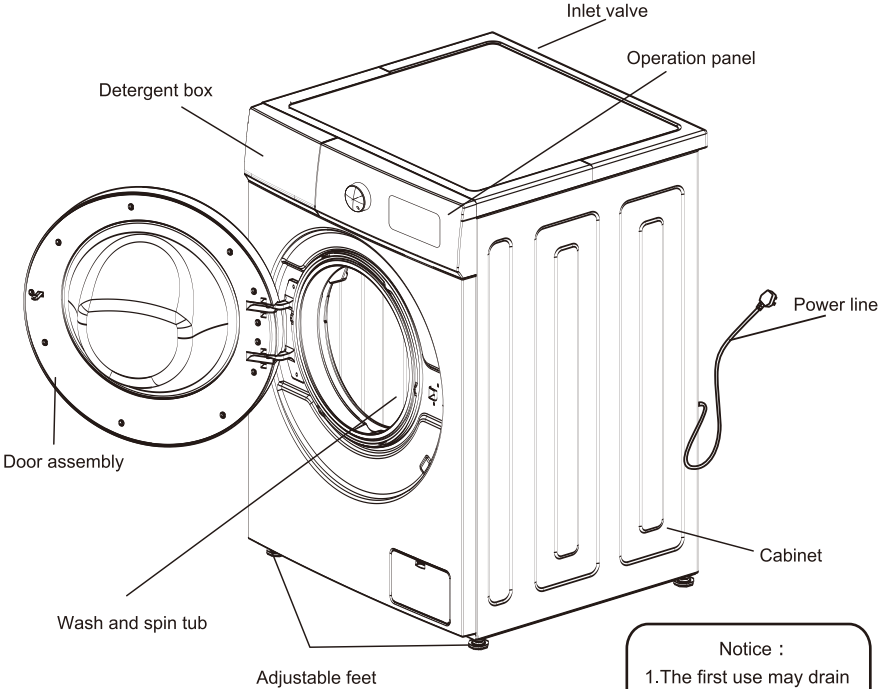

Important notice:

- 1.The product appearance and specifications may be varied without notice to raise the product quality.
- 2.The product appearance and specifications may be varied with that of the related energy efficiency test or the related safety test,etc.

Notice :

- 1.The first use may drain some water out. It's residual water after performance test, belong to the normal phenomenon.
- 2.After each use, please pull the plug and turn off the faucet to prevent accidental flood or fire.

Installation instruction

- Make sure the temperature of the places where the washer is installed or placed is above 0°C
- Place the washer correctly according to management standards and regulations.
- Keep the base of washer ventilated when it is placed on the ground with carpet.
- Please keep the surroundings clean, any damage caused by cockroaches or other pests will not be covered under warranty.

Transport bolt

Washers are installed with transport bolts to prevent internal damage in transit.

Dismantle the transport bolt

1. In order to prevent internal damage in transit, 4 bolts are installed. Before using the washer, dismantle the bolt (see chart 1).
- If the bolts are not dismantled, violent vibration, noise and trouble will be caused.
2. Use the attached wrench to loosen the 4 bolts (see chart 2).
 3. Twist the bolt rubber slightly and then pull out the bolts, keep the bolts and wrench as standby (see chart 3).
- The bolts should be remounted if you need to transport the washer.
4. Use attached stopples to seal the screw holes (see chart 4).

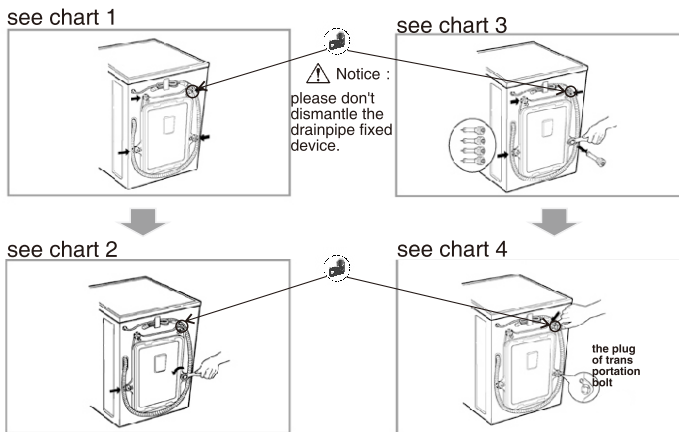

Requires for positions

Horizontal adjustment:

- The slant angle should be less than 1 degree.

Power outlet

- The distance between any side of the washer and power outlet should be within 1.5 meters.
- Don't use too many electrical appliances in one outlet.

Environment cleaning

- It's necessary to clean the wall, door and ground.
- Install the washer on a hard and steady ground with floor drain rather than soft blanket or wooden floor.
- Don't put dirty clothes or some other goods on a washer's head cover, otherwise it may impact the normal operation.

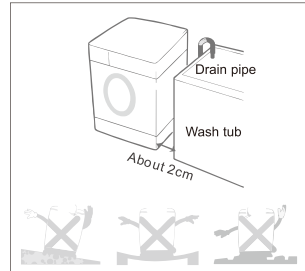

⚠ Notice

Power connection

1. Don't use the wiring board.
 2. If the power lines are damaged, please contact professionals to repair them.
 3. After the use of washer, pull the plug and turn the tap off.
 4. Connect the washer with grounded outlet to correspond to the wiring principles.
 5. Place the washer in which is easy to connect the outlet.
- Contact the maintenance center and ask professionals to repair the washer. Unauthorised engineers may cause damage to the washer.
 - Don't put the washer where the temperature is below zero. The pipes may freeze and break. Moreover, the temperature below zero will damage the programming controller.
 - If moving the washer to an environment where the temperature is below zero, please keep the washer at room temperature for a few hours before starting it.

Grounding introduction

- A washer must have grounding devices. If a fault happens, the device can reduce the risk of electrical shock. The device is equipped with a cable (including a wire and a grounded plug). The grounded plug must be inserted in an appropriate outlet. If you want to know if the washer is grounded correctly, please contact professional maintenance staff. If the plug can't match with the outlet, please don't change the plug by yourself.
- Once your washer smokes or emits an odor, please turn off the power and contact with professional maintenance staff.

Washers should be connected to water inlet. Please use the attached new plumbing rather than the old.

To ensure the quality, water injection tests are carried out before the washer leaves the factory, so there may be water inside the internal tub, door seals and door panel, which are normal.

Water inlet connection

1. The pressure of supply water should be between 30kPa and 1000kPa.
 2. Don't abrade the screw thread when connect the inlet pipes with valves.
 3. Please install dropping equipment if the pressure of supply water surpasses 1000kPa.
- Two seals are supplied in the connectors of both ends of the pipe to prevent water leaking.
 - Turn on the tap and check if the connectors leak.
 - Check the pipes regularly. Please change them if necessary.
 - Make sure the pipes are not damaged or twine with each other.

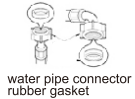
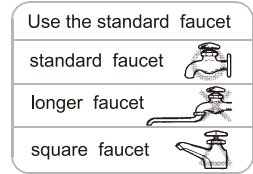

The connection of inlet pipes and taps

- 1** Check the rubber seals on both sides of the hose.
-insert a rubber seal into the threaded fittings on each hose to prevent leaking.

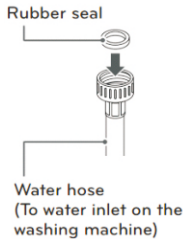

- 2** Connect the water supply hoses to the water faucets tightly by hand and then tighten another 2/3 turn with pliers.
-Connect the blue hose to the water faucet.

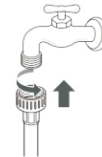

⚠ WARNING
• Do not overtighten. Damage to the coupling can result.

- 3** After connecting inlet hose to water faucets, turn on the water faucets to flush out foreign substances (dirt, sand or sawdust) in the water lines. Let water drain into a bucket water temperature.

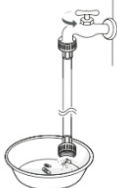

- 4** Connect the hoses to the water inlet tightly by hand and then tighten another 2/3 turn with pliers.

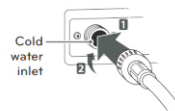

⚠ WARNING
• Do not overtighten the hoses. Overtightening can damage the valves resulting in leaking and property damage.

- 5** Check for leaks by turning on the faucets. If water leaks, check steps 1 to 4 again.

- This washing machine is designed for home appliances, please do not install it on ship, traveling truck or plane.
- Please turn off the stopcock if long time out of use. (e.g. Vacation)
- Please remove the plug and cancel door lock function to avoid child locking himself/herself inside.
- Packing materials (e.g film, foam) could harm a child's safety and cause asphyxia! Attention: MAKE ALL PACKING MATERIEALS OUT OF CHILD REACH.

Install drainpipe

- Please fix the drainpipe with a lifting rope.
- For the sake of lightening damage of leak towards ground, please place the drainpipe correctly.
- To avoid siphon, the height of drainpipe should be between (0.85m-1.25m), moreover, the terminal of this should not be placed in water.
- If the drainpipe is too long, please do not force to insert it into washing machine, which would cause abnormal noise. (Please check sketch map next page)

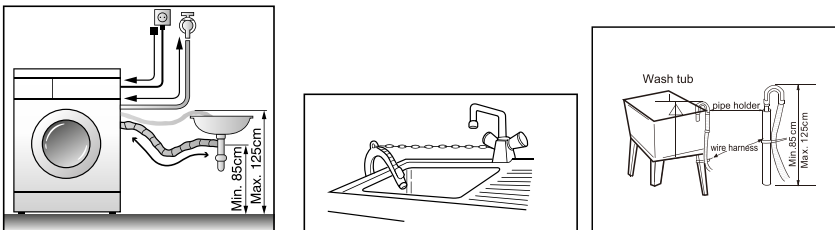

The instruction of installation of pipe

Horizontal Adjustment

- To avoid noise and vibration adjust washing machine level. Ideally place it in the corner of the room.
- If the ground is not level, please adjust the alignment pins. Do not use wood pieces or similar, please make sure four alignment pins touch ground tightly, and machine is completely level.

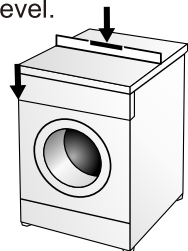

- Adjust adjustable feet

Adjust the adjustable feet to make sure the washing machine is in balance, which can be placed on the ground steadily. After settling, screw the locknut to guarantee. Do not place the washing machine in the platform, which is higher than the ground, in order to prevent the machine from falling down because of other accidents.

- The diagonal check

Applying force downward on the diagonal of the washing machine, washing machine should not shake. (Both diagonal need to check, if the washing machine shake, must readjust adjustable foot.)

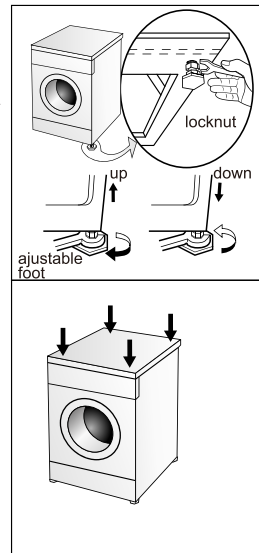

Methods of Door Lock and Remove

DOOR LOCK

- After operating, the door will be locked automatically and "DOOR LOCK" light/picture on the panel is lighting.

Remove Door Lock

- When "DOOR LOCK" light/picture is lighting. Press "Start/pause", WASHING/DEWATERING drum stop operating. Please wait for about 2 minutes. Door lock will be removed automatically.
- Foam overflowing if the door is opened during operation, please catch foam with a towel.
- If the temperature is too high, the door cannot be opened during operation.
- If water level is too high, the door can not be open during operating.

The Usage Method of the Detergent Box

Synthetic Detergent Powder 

- Please dissolve detergent (e.g soap pieces) before putting into detergent box.

Liquid detergent. Bleach 

- Please use detergent with less foam.
- Please use two times water to dilute the concentrated type detergent before putting into detergent box.

Softener 

- Please put softener before washing, which will pour into drum automatically when last patch happening.
- When using concentrated type softener, please dilute it with appropriate water.
- Do not exceed MAX mark.

Prewashing Detergent 

- Please put moderate detergent after selecting Pre-washing function if cloths is too dirty.

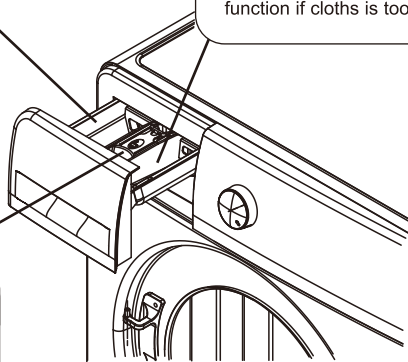

- Use special detergent.
- Do not use too much detergent which will cause too much foam and affect washing quality or will cause malfunction.
- Select detergent according to cloths variety, color, water temperature and contamination level.
- Please use moderate detergent to get washing effect and protect environment.

The Recommendations on detergent use at the various temperatures

- When washing heavily soiled whites, we recommend using cotton programs of 60°(or above and a normal washing powder(heavy duty) that contains bleaching agents that at medium/high temperatures provide excellent results.
- For washes between 40°(and 60°(,the type of detergent used needs to be appropriate for the type of fabric and level of soiling. Normal powders are suitable for "white" or color fast fabrics with high soiling, while liquid detergents or "color protecting" powders are suitable for colored fabrics with light levels of soiling.
- For washing at temperatures below 40°(we recommend the use of liquid detergents or detergents specifically labeled as suitable for low temperature washing.

Function Introduction of Operating Panel

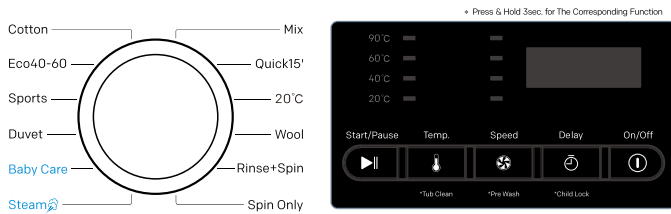

Image shown here is indicative only. Actual product you receive may differ.

1. On/Off Button

- Turn on or turn off power.
- When procedure finish, press On/Off to cut off power.

2. Delay Button

- Delay Time
- Delay time refers to the period from appoint to end .

3. Speed Button

- Select the Speed according to the capacity and variety of cloths.
- Different procedure, different speed select range, but the speed of drum clearance no choice.

4. Temp. Button

- Select water temperature according to the variety and contamination degree.
- Different procedure, different water temperature range, some no choice.

5. Start/Pause Button

- Press it to start operating
- Press it to pause during operation, press again to continue.

6. Program Button

- Select program according to variety and contamination of cloths.

7. Tub Clean

- For the sake of clearing the scouring remained, and completing sterilization&disinfection
- Press Temp. for more than 3 seconds to start tub clean program.

8. Pre Wash Button

- If the cloths are too dirty, you can choose this program before washing.
- Press Speed for more than 3 seconds to start pre wash program.

9. Child-Lock Button

- Press it to guard against child operating.
- Child-Lock operating, other buttons unavailable except On/Off.
- Press Delay for more than 3 seconds to ON/OFF Child-Lock function.

The introduction of function and program

Usage of routine clothes

1.Preparations

- Open the door put clothes in and closes the door.
- Pull out the detergent box, add detergent and close the box.
- Connect the inlet pipes and make sure the tap turned on.

2.Press the On/Off button

3.The programs can be selected according to requirements.

4. According to the need, push corresponding button to set water temperature, spin speed, delay time.

5.Press Start/Pause button and begin to wash.

6.When all operations finished, the buzzer emits a noise.

- Open the door to get cloths out.
- Unplug and turn off the stopcock.

- If you want to change the current setting during the process of washing, please push "Start/Pause" button first and stop washing, then push button to reset.

Cotton Program Introduction

This program is suitable for the clothes which are moderate or mild dirty, like cotton, beddings, underwear, towels and shirt, etc...

Eco Program

Wash the clothes lightly polluted can save time and energy.

Sports Program Introduction

Used for washing sports clothes, can wash the sweat and dirt on the clothes

Duvet Program Introduction

Used for washing heavy clothes, such as coats, big towels and so on

Baby Care Program Introduction

Used for washing baby clothes to make clothes cleaner.

Steam Program

The steam function is activated to have the inner drum environment heated, leading to the improvement on washing performance and dirt reduced.

Mix Program Introduction

This function can be used to wash mix clothes like cotton, synthetic and so on (please do not mix wash the clothes that easily rub off).

Quick 15' Program Introduction

To wash clothes that are changed frequently, not too dirty and thin clothes

Synthetic Program Introduction

To wash the synthetic clothes

Wool Program Introduction

For washing wool fabrics marked "machine washable"

Rinse + Spin Program Introduction

The machine will not wash, only rinse and spin.

Spin Only Program

The machine will not wash and rinse, only spin.

- During the process of spinning, the actual spinning speed may be inconsistent with the program speed, which is because the washer adjust the speed according to the balance between clothes.

Introduction of Washing Programs

P35106SYIN-A P35106SKW-A

Program	Temperature (°C)	Spin Speed (Run/Min.)	Time(m)
Cotton	cold water(20,40,60,90)	800(0,400,600,1000)	88
Eco40-60	40(cold water,20,60)	1000(0,400,600,800)	135
Sports	20(cold water,40)	800(0,400,600)	79
Duvet	60(cold water,20,40,90)	1000(0,400,600,800)	118
Baby Care	60(40,90)	800(0,400,600)	109
Steam	20(cold water,40,60,90)	800(0,400,600,1000)	83
Mix	cold water(20,40)	800(0,400,600)	66
Quick 15'	cold water(20,40)	600(0,400,800)	15
20°C	20	1000(0,400,600,800)	63
Wool	cold water(20,40)	600(0,400)	56
Rinse+Spin	——	800(0,400,600,1000)	20
Spin Only	——	800(0,400,600,1000)	14

- Remarks:
 - 1.The time consumption will be changed according to the water pressure, cloths variety, quantity, water temperature.
 - 2.The difference between displayed on screen and actual time consumption will happen.
 - 3.If speed is too lower, poor washing effect will happen, please add more rinse time.
 - 4.Different parameters, different models.
 - 5.When self-designed default procedure is energy procedure, the washing time will be increased automatically.
- The eco 40-60 programme is able to clean normally soiled cotton laundry declared to be washable at 40 °C or 60 °C, together in the same cycle, and that this programme is used to assess the compliance with the EU ecodesign legislation;
- The most efficient programmes in terms of energy consumption are generally those that perform at lower temperatures and longer duration;
- The household washing machine or the household washer-dryer up to the capacity indicated by the manufacturer for the respective programmes will contribute to energy and water savings;
- Noise and remaining moisture content are influenced by the spinning speed: the higher the spinning speed in the spinning phase, the higher the noise and the lower the remaining moisture content
- How to find the model information stored in the product database, as defined in Regulation (EU) 2019/2014 by means of a weblink that links to the model information as stored in the product database or a link to the product database and information on how to find the model identifier on the product
- You can Check the manual and the QR code on the energy efficiency label

Introduction of Washing Programs

P35147SKW-A

Program	Temperature (°C)	Spin Speed (Run/Min.)	Time(m)
Cotton	cold water(20,40,60,90)	1000(0,400,800,1400)	94
Eco40-60	40(cold water,20,60)	1400(0,400,800,1000)	145
Sports	20(cold water,40)	1000(0,400,800)	83
Duvet	60(cold water,20,40,90)	1400(0,400,800,1000)	125
Baby Care	60(40,90)	1000(0,400,800)	130
Steam	20(cold water,40,60,90)	800(0,400,1000,1400)	83
Mix	cold water(20,40)	1000(0,400,800)	73
Quick 15'	cold water(20,40)	800(0,400,1000)	15
20°C	20	1000(0,400,800,1400)	63
Wool	cold water(20,40)	800(0,400,1000)	57
Rinse+Spin	——	1000(0,400,800,1400)	38
Spin Only	——	1000(0,400,800,1400)	14

- Remarks:

- 1.The time consumption will be changed according to the water pressure, cloths variety, quantity, water temperature.
 - 2.The difference between displayed on screen and actual time consumption will happen.
 - 3.If speed is too lower, poor washing effect will happen, please add more rinse time.
 - 4.Different parameters, different models.
 - 5.When self-designed default procedure is energy procedure, the washing time will be increased automatically.
- The eco 40-60 programme is able to clean normally soiled cotton laundry declared to be washable at 40 °C or 60 °C, together in the same cycle, and that this programme is used to assess the compliance with the EU ecodesign legislation;
 - The most efficient programmes in terms of energy consumption are generally those that perform at lower temperatures and longer duration;
 - The household washing machine or the household washer-dryer up to the capacity indicated by the manufacturer for the respective programmes will contribute to energy and water savings;
 - Noise and remaining moisture content are influenced by the spinning speed: the higher the spinning speed in the spinning phase, the higher the noise and the lower the remaining moisture content
 - How to find the model information stored in the product database, as defined in Regulation (EU) 2019/2014 by means of a weblink that links to the model information as stored in the product database or a link to the product database and information on how to find the model identifier on the product
 - You can Check the manual and the QR code on the energy efficiency label

Introduction of Washing Programs

P35148SSYIN-A / P35148SKW-A / P35149SKW-A /
P351410SKW-A / P351410SYIN-A

Program	Temperature (°C)	Spin Speed (Run/Min.)	Time(m)
Cotton	cold water(20,40,60,90)	1000(0,400,800,1400)	94
Eco40-60	40(cold water,20,60)	1400(0,400,800,1000)	158
SPorts	20(cold water,40)	1000(0,400,800)	83
Duvel	60(cold water,20,40,90)	1400(0,400,800,1000)	125
Baby Care	60(40,90)	1000(0,400,800)	130
Steam	20(cold water,40,60,90)	800(0,400,1000,1400)	83
Mix	cold water(20,40)	1000(0,400,800)	73
Quick 15	cold water(20,40)	800(0,400,1000)	15
20°C	20	1000(0,400,800,1400)	63
Wool	cold water(20,40)	800(0,400,1000)	57
Rinse+Spin	—	1000(0,400,800,1400)	38
Spin Only	—	1000(0,400,800,1400)	14

- Remarks:

- The time consumption will be changed according to the water pressure, cloths variety, quantity, water temperature.
 - The difference between displayed on screen and actual time consumption will happen.
 - If speed is too lower, poor washing effect will happen, please add more rinse time.
 - Different parameters, different models.
 - When self-designed default procedure is energy procedure, the washing time will be increased automatically.
- The eco 40-60 programme is able to clean normally soiled cotton laundry declared to be washable at 40 °C or 60 °C, together in the same cycle, and that this programme is used to assess the compliance with the EU ecodesign legislation;
 - The most efficient programmes in terms of energy consumption are generally those that perform at lower temperatures and longer duration;
 - The household washing machine or the household washer-dryer up to the capacity indicated by the manufacturer for the respective programmes will contribute to energy and water savings;
 - Noise and remaining moisture content are influenced by the spinning speed: the higher the spinning speed in the spinning phase, the higher the noise and the lower the remaining moisture content
 - How to find the model information stored in the product database, as defined in Regulation (EU) 2019/2014 by means of a weblink that links to the model information as stored in the product database or a link to the product database and information on how to find the model identifier on the product
 - You can Check the manual and the QR code on the energy efficiency label

Maintenance

- Please maintenance washing machine to extend service life.
- Before maintenance, please unplug.

Body of washing machine

After washing, please clean it with soft cloth. If much contamination, please use appropriate detergent or soap.

- Do not watering directly.
- Do not use putty-powder, diluent, gasoline, alcohol to clean machine body.

Door Gasket Ring

After washing, please remove contamination, wastepaper and so on, if foreign matter exists, please remove.

The Clearance of Detergent Box

Please clean the detergent box regularly. Pull it out and wash with clean water, then insert back.

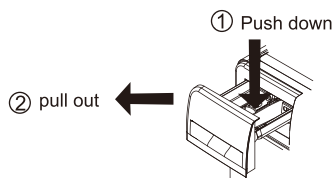

The Clearance of Universal coupling (Suggest:Once/ half year)

- If waste accumulated, it will influence water inlet speed.

1. Take off the soft pipe from connecting part side.
2. Take off the screwing device according to the arrow showed.
3. Wash the inside of the screwing device.
4. Install the cleaned crewing device with the inlet soft pipe.



The clearance of inlet water valve (Suggest:Once/ half year)

1. Take off the soft pipe from washing machine side.
2. Take off the filter net from water valve.
3. Clean the filter net with tooth-brash.
4. Install the soft inlet pipe.

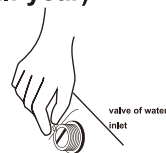

Maintenance

When washing machine is frozen

1. Cover stopcock and connecting part with hot towel.
2. Take off the inlet pipe, and put it into 50 degree water.
3. Pour into the drum about 2-3L of 50 degree water.
4. Connect inlet pipe, turn on the stopcock and start the washing machine, please check whether inlet and outlet is normal.

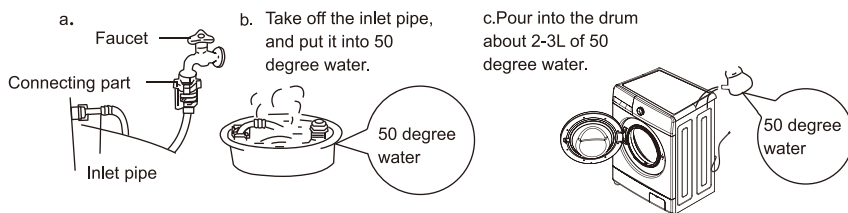

The Clearance of dewatering-pump filter(Suggest: once/month)

1. Press fastener on the pump after dewatering and power off, open the lid of water-pump filter.(Attention: if hot water inside, please go ahead after it be cold.)
2. Take off the filter anti-anticlockwise.
3. Wash the filter.
4. Direct at pump and insert the filter, tighten it clockwise and tighten the lid. Attention: a. Please tighten the filter well to avoid leak. b. Please do not clean during operation.

The Drum Clearance (Suggest once/month)

After using for a period, some dirt maybe exist. You can clean the inside and outside of drum by operating the drum procedure.
Attention: please do not put cloths and detergent when clearing the drum.

Varieties of Functions

Function	Description	
Child lock	Statement	In order to avoid child misplay
	Setup to remove	During operation, press DELAY for more than 3 seconds, please unplug and or press DELAY to remove Child Lock
Intellectual lock-remove	Statement	When operation is over, if water insie is higher, the Drain water pump is be on to drain to the open lock water level and stop.
compensation of power-off	Statement	when power is connected after power off, the time point will continue from the previous stop time point.
Door self-lock	Statement	After selecting procedure, the door locked automatically, a few seconds after operation over, lock removed.
Clearance of the drum	Statement	To remove wasted and germ, please sterilize to clean the drum.
	Setup to remove	Press Temp. for more than 3 seconds to select tub clean.
Delay	Statement	Press DELAY to select time of washing , Display screen shows 24 hours level, one hour/one level . press it for long time, time shows circular.

- Check the door seals and make sure there is nothing on them.
- Make sure there is nothing in the tub before washing.
- Please use the low bubble detergent specially for front loading washing to wash the cloths.

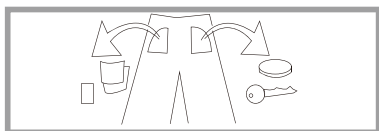
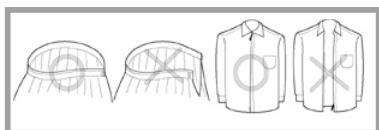
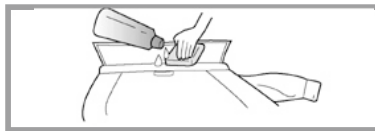
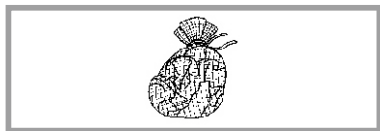

Non-fault conditions

The door can't open.	<ul style="list-style-type: none">● The program is running.● There are clothes between the door and door seals.
There is an odor.	<ul style="list-style-type: none">● There may be a smell of rubber because some components are made up of rubber.
There is too little water when wash and rinse.	<ul style="list-style-type: none">● Roller washing machine just needs a little water when operating.
No water inflowing.	<ul style="list-style-type: none">● Is the tap turned on?● Is the inlet pipe frozen?● Are the filters blocked?
Water inflows halfway	<ul style="list-style-type: none">● If the water level declines, the washer will supply water automatically.
Water outflows when washing.	<ul style="list-style-type: none">● Check if add the detergent with too much bubbles.
Remaining time changes	<ul style="list-style-type: none">● If clothes are off center when spin, spinning time will extend to correct the deviation.
There is abnormal noise when spin.	<ul style="list-style-type: none">● Check if the power line touches with cabinet.● Have the transport bolts been dismantled?● Are there some hairpins or coins in the roller?
The washer can't work after the failure of electricity.	<ul style="list-style-type: none">● The washer will stop working after the failure of electricity. When the power is restored, it still can't continue to work. Please press the power button and reset the program.

Troubleshooting Guide

Phenomenon	check points	solutions
Washer can't start	<ul style="list-style-type: none"> ● Check if press the power button or start/pause button? ● Is the plug pulling out? ● Is there a power failure? ● Check if cut the leakage protector? 	Press the power button or start/pause button. Connect the plug. Please wait. Open the leakage protector.
Spinning screen shows "UE"	<ul style="list-style-type: none"> ● Check if disassemble the carriage bolt? ● Is the machine placed steadily? ● Are the clothes too small or light? ● Are the locknuts on under the feet tightened up? 	Disassemble the carriage bolt. Place the machine on a steady ground. Add more clothes. Tighten up the locknuts.
Water inflow screen shows "IE"	<ul style="list-style-type: none"> ● Check if turn the tap off? ● Is the water supply cut off or the water pressure too low? ● Are the water inlet pipes frozen? ● Are the filters blocked? 	Open the stopcock. Please wait. Use hot water to unfreeze the pipes. Take out the filters and clean them.
Water outflow screen shows "OE"	<ul style="list-style-type: none"> ● Are the outlet pipes placed too highly? ● Are the outlet pipes frozen? ● Are the outlet pipes blocked? ● Are the floor drain blocked? 	Please put away the outlet pipes and make sure the height within 1M. Use hot water to unfreeze the pipes. Take out the foreign matter and dredge the pipes. Clean the floor drain.
Door trouble screen shows "DE"	<ul style="list-style-type: none"> ● Make sure if start the washer without closing the door well. 	Make sure the door truly closed
No heating screen shows "LE"	Please pull the plug and entrust the after-sales service	
Continuous water inflow screen shows "FE"	Close the stopcock, pull the plug and entrust the after-sales service.	
The screen shows "LE" or "CE" when wash tub doesn't rotate.	Close the stopcock, pull the plug and entrust the after-sales service.	
Too much foam	<ul style="list-style-type: none"> ● Check if add too much detergent? ● If use the low bubble detergent which is especially for front loading washing machine? 	Add reasonable amount of detergent. Use the detergent correctly.

Specification

Model	P35106SKW-A P35106SYIN-A	P35147SKW-A	P35148SSYIN-A P35148SKW-A
Rated washing capacity	6.0kg	7.0kg	8.0kg
Rated spinning capacity	6.0kg	7.0kg	8.0kg
Rated voltage	220-240V~, 50Hz		
Rated washing power	200W	200W	350W
Rated spinning power	500W	500W	700W
Rated heating power	1500W	1800W	1600W
Maximum power	1650W	1950W	1750W

Model	P35149SKW-A	P351410SKW-A P351410SYIN-A
Rated washing capacity	9.0kg	10.0kg
Rated spinning capacity	9.0kg	10.0kg
Rated voltage	220-240V~, 50Hz	
Rated washing power	200W	200W
Rated spinning power	600W	500W
Rated heating power	2000W	1800W
Maximum power	2200W	1950W

Specification and feature are subject to change without prior notice for purpose of product improvement .

PRODUCT FICHE

Supplier's name or trade mark:

Supplier's address ^(b):

Model identifier: P35106SKW-A P35106SYIN-A

General product parameters:

Parameter	Value		Parameter	Value	
Rated capacity ^(a) (kg)	6.0		Dimensions in cm	Height	85
				Width	60
				Depth	44
EE _w ^(a)	52.0		Energy efficiency class ^(a)	A	
Washing efficiency index ^(a)	1.031		Rinsing effectiveness (g/kg) ^(a)	5.0	
Energy consumption in kWh per cycle, based on the eco 40-60 programme. Actual energy consumption will depend on how the appliance is used.	0.421		Water consumption in litre per cycle, based on the eco 40-60 programme. Actual water consumption will depend on how the appliance is used and on the hardness of the water.	36	
Maximum temperature inside the treated textile ^(a) (°C)	Rated capacity	30	Remaining moisture content ^(a) (%)	62.9	
	Half	24			
	Quarter	21			
Spin speed ^(a) (rpm)	Rated capacity	1000	Spin-drying efficiency class ^(a)	C	
	Half	1000			
	Quarter	1000			
Programme duration ^(a) (h:min)	Rated capacity	3:18	Type	free-standing	
	Half	2:36			
	Quarter	2:36			
Airborne acoustical noise emissions in the spinning phase ^(a) (dB(A) re 1 pW)	76		Airborne acoustical noise emission class ^(a) (spinning phase)	B	
Off-mode (W)	0.50		Standby mode (W)	N/A	
Delay start (W) (if applicable)	4.00		Networked standby (W) (if applicable)	N/A	

Minimum duration of the guarantee offered by the supplier ^(b):

This product has been designed to release silver ions during the washing cycle

NO

Additional information:

Weblink to the supplier's website, where the information in point 9 of Annex II to Commission Regulation (EU) 2019/2023 (1) (b) is found:

^(a) for the eco 40-60 programme.

^(b) changes to these items shall not be considered relevant for the purposes of paragraph 4 of Article 4 of Regulation (EU) 2017/1369.

^(c) if the product database automatically generates the definitive content of this cell the supplier shall not enter these data.

Information to be included in the technical documentation for household washing machines

PARAMETER	UNIT	VALUE
Rated capacity for the eco 40-60 programme, at 0,5 kg intervals (c)	kg	6.0
Energy consumption of the eco 40-60 programme at rated capacity ($E_{w,full}$)	kWh/cycle	0.605
Energy consumption of the eco 40-60 programme at half rated capacity ($E_{w,1/2}$)	kWh/cycle	0.320
Energy consumption of the eco 40-60 programme at quarter rated capacity ($E_{w,1/4}$)	kWh/cycle	0.205
Weighted energy consumption of the eco 40-60 programme (E_w)	kWh/cycle	0.421
Standard energy consumption of the eco 40-60 programme (SCE_w)	kWh/cycle	0.810
Energy Efficiency Index (EEL_w)	—	52.0
Water consumption of the eco 40-60 programme at rated capacity ($W_{w,full}$)	L/cycle	40.0
Water consumption of the eco 40-60 programme at half rated capacity ($W_{w,1/2}$)	L/cycle	35.0
Water consumption of the eco 40-60 programme at quarter rated capacity ($W_{w,1/4}$)	L/cycle	30.0
Weighted water consumption (W_w)	L/cycle	36
Washing efficiency index of the eco 40-60 programme at rated capacity (I_w)	—	1.031
Washing efficiency index of the eco 40-60 programme at half rated capacity (I_w)	—	1.031
Washing efficiency index of the eco 40-60 programme at quarter rated capacity (I_w)	—	1.031
Rinsing effectiveness of the eco 40-60 programme at rated capacity (I_R)	g/kg	5.0
Rinsing effectiveness of the eco 40-60 programme at half rated capacity (I_R)	g/kg	5.0
Rinsing effectiveness of the eco 40-60 programme at quarter rated capacity (I_R)	g/kg	5.0
Programme duration of the eco 40-60 programme at rated capacity (t_w)	h:min	3:18
Programme duration of the eco 40-60 programme at half rated capacity (t_w)	h:min	2:36
Programme duration of the eco 40-60 programme at quarter rated capacity (t_w)	h:min	2:36
Temperature reached for minimum 5 min inside the load during eco 40-60 programme at rated capacity (T)	°C	30
Temperature reached for minimum 5 min inside the load during eco 40-60 programme at half rated capacity (T)	°C	24
Temperature reached for minimum 5 min inside the load during eco 40-60 programme at quarter rated capacity (T)	°C	21
Spin speed in the spinning phase of the eco 40-60 programme at rated capacity (S)	rpm	1000
Spin speed in the spinning phase of the eco 40-60 programme at half rated capacity (S)	rpm	1000
Spin speed in the spinning phase of the eco 40-60 programme at quarter rated capacity (S)	rpm	1000
Weighted remaining moisture content (D)	%	62.9
Airborne acoustical noise emissions during eco 40-60 programme (spinning phase)	dB(A) re 1 pW	76
Power consumption in 'off mode' (P_o)	W	0.50
Power consumption in 'standby mode' (P_{sm})	W	N/A
Does 'standby mode' include the display of information?	—	NO
Power consumption in 'standby mode' (P_{sm}) in condition of networked standby (if applicable)	W	N/A
Power consumption in 'delay start' (P_{ds}) (if applicable)	W	4.00

PRODUCT FICHE

Supplier's name or trade mark:

Supplier's address ^(b):

Model identifier: P35147SKW-A

General product parameters:

Parameter	Value		Parameter	Value	
Rated capacity ^(a) (kg)	7.0		Dimensions in cm	Height	85
				Width	60
				Depth	48
EE _w ^(a)	52.0		Energy efficiency class ^(a)	A	
Washing efficiency index ^(a)	1.031		Rinsing effectiveness (g/kg) ^(a)	5.0	
Energy consumption in kWh per cycle, based on the eco 40-60 programme. Actual energy consumption will depend on how the appliance is used.	0.448		Water consumption in litre per cycle, based on the eco 40-60 programme. Actual water consumption will depend on how the appliance is used and on the hardness of the water.	37	
Maximum temperature inside the treated textile ^(a) (°C)	Rated capacity	31	Remaining moisture content ^(a) (%)	53.9	
	Half	25			
	Quarter	21			
Spin speed ^(a) (rpm)	Rated capacity	1400	Spin-drying efficiency class ^(a)	B	
	Half	1400			
	Quarter	1400			
Programme duration ^(a) (h:min)	Rated capacity	3:28	Type	free-standing	
	Half	2:42			
	Quarter	2:42			
Airborne acoustical noise emissions in the spinning phase ^(a) (dB(A) re 1 pW)	76		Airborne acoustical noise emission class ^(a) (spinning phase)	B	
Off-mode (W)	0.50		Standby mode (W)	N/A	
Delay start (W) (if applicable)	4.00		Networked standby (W) (if applicable)	N/A	

Minimum duration of the guarantee offered by the supplier ^(b):

This product has been designed to release silver ions during the washing cycle

NO

Additional information:

Weblink to the supplier's website, where the information in point 9 of Annex II to Commission Regulation (EU) 2019/2023 (1) (b) is found:

^(a) for the eco 40-60 programme.

^(b) changes to these items shall not be considered relevant for the purposes of paragraph 4 of Article 4 of Regulation (EU) 2017/1369.

^(c) if the product database automatically generates the definitive content of this cell the supplier shall not enter these data.

Information to be included in the technical documentation for household washing machines

PARAMETER	UNIT	VALUE
Rated capacity for the eco 40-60 programme, at 0,5 kg intervals (c)	kg	7.0
Energy consumption of the eco 40-60 programme at rated capacity ($E_{w,full}$)	kWh/cycle	0.895
Energy consumption of the eco 40-60 programme at half rated capacity ($E_{w,1/2}$)	kWh/cycle	0.699
Energy consumption of the eco 40-60 programme at quarter rated capacity ($E_{w,1/4}$)	kWh/cycle	0.361
Weighted energy consumption of the eco 40-60 programme (E_w)	kWh/cycle	0.688
Standard energy consumption of the eco 40-60 programme (SCE_w)	kWh/cycle	0.860
Energy Efficiency Index (EEI_w)	—	79.8
Water consumption of the eco 40-60 programme at rated capacity ($W_{w,full}$)	L/cycle	45.8
Water consumption of the eco 40-60 programme at half rated capacity ($W_{w,1/2}$)	L/cycle	25.9
Water consumption of the eco 40-60 programme at quarter rated capacity ($W_{w,1/4}$)	L/cycle	20.6
Weighted water consumption (W_w)	L/cycle	45
Washing efficiency index of the eco 40-60 programme at rated capacity (I_w)	—	1.031
Washing efficiency index of the eco 40-60 programme at half rated capacity (I_w)	—	1.031
Washing efficiency index of the eco 40-60 programme at quarter rated capacity (I_w)	—	1.031
Rinsing effectiveness of the eco 40-60 programme at rated capacity (I_R)	g/kg	5.0
Rinsing effectiveness of the eco 40-60 programme at half rated capacity (I_R)	g/kg	5.0
Rinsing effectiveness of the eco 40-60 programme at quarter rated capacity (I_R)	g/kg	5.0
Programme duration of the eco 40-60 programme at rated capacity (t_w)	h:min	3:14
Programme duration of the eco 40-60 programme at half rated capacity (t_w)	h:min	2:35
Programme duration of the eco 40-60 programme at quarter rated capacity (t_w)	h:min	2:31
Temperature reached for minimum 5 min inside the load during eco 40-60 programme at rated capacity (T)	°C	40
Temperature reached for minimum 5 min inside the load during eco 40-60 programme at half rated capacity (T)	°C	41
Temperature reached for minimum 5 min inside the load during eco 40-60 programme at quarter rated capacity (T)	°C	39
Spin speed in the spinning phase of the eco 40-60 programme at rated capacity (S)	rpm	1400
Spin speed in the spinning phase of the eco 40-60 programme at half rated capacity (S)	rpm	1400
Spin speed in the spinning phase of the eco 40-60 programme at quarter rated capacity (S)	rpm	1400
Weighted remaining moisture content (D)	%	53.5
Airborne acoustical noise emissions during eco 40-60 programme (spinning phase)	dB(A) re 1 pW	75
Power consumption in 'off mode' (P_o)	W	0.50
Power consumption in 'standby mode' (P_{sm})	W	N/A
Does 'standby mode' include the display of information?	—	NO
Power consumption in 'standby mode' (P_{sm}) in condition of networked standby (if applicable)	W	N/A
Power consumption in 'delay start' (P_{ds}) (if applicable)	W	4.00

PRODUCT FICHE

Supplier's name or trade mark:

Supplier's address ^(b):

Model identifier: P35148SSYIN-A P35148SKW-A

General product parameters:

Parameter	Value		Parameter	Value	
Rated capacity ^(a) (kg)	8.0		Dimensions in cm	Height	85
				Width	60
				Depth	51
EE _w ^(a)	52.0		Energy efficiency class ^(a)	A	
Washing efficiency index ^(a)	1.031		Rinsing effectiveness (g/kg) ^(a)	5.0	
Energy consumption in kWh per cycle, based on the eco 40-60 programme. Actual energy consumption will depend on how the appliance is used.	0.473		Water consumption in litre per cycle, based on the eco 40-60 programme. Actual water consumption will depend on how the appliance is used and on the hardness of the water.	37	
Maximum temperature inside the treated textile ^(a) (°C)	Rated capacity	33	Remaining moisture content ^(a) (%)	53.9	
	Half	28			
	Quarter	23			
Spin speed ^(a) (rpm)	Rated capacity	1400	Spin-drying efficiency class ^(a)	B	
	Half	1400			
	Quarter	1400			
Programme duration ^(a) (h:min)	Rated capacity	3:38	Type	free-standing	
	Half	2:50			
	Quarter	2:50			
Airborne acoustical noise emissions in the spinning phase ^(a) (dB(A) re 1 pW)	76		Airborne acoustical noise emission class ^(a) (spinning phase)	B	
Off-mode (W)	0.52		Standby mode (W)	N/A	
Delay start (W) (if applicable)	4.00		Networked standby (W) (if applicable)	N/A	

Minimum duration of the guarantee offered by the supplier ^(b):

This product has been designed to release silver ions during the washing cycle

NO

Additional information:

Weblink to the supplier's website, where the information in point 9 of Annex II to Commission Regulation (EU) 2019/2023 (1) (b) is found:

^(a) for the eco 40-60 programme.

^(b) changes to these items shall not be considered relevant for the purposes of paragraph 4 of Article 4 of Regulation (EU) 2017/1369.

^(c) if the product database automatically generates the definitive content of this cell the supplier shall not enter these data.

Information to be included in the technical documentation for household washing machines

PARAMETER	UNIT	VALUE
Rated capacity for the eco 40-60 programme, at 0,5 kg intervals (c)	kg	8.0
Energy consumption of the eco 40-60 programme at rated capacity ($E_{w,full}$)	kWh/cycle	0.747
Energy consumption of the eco 40-60 programme at half rated capacity ($E_{w,1/2}$)	kWh/cycle	0.425
Energy consumption of the eco 40-60 programme at quarter rated capacity ($E_{w,1/4}$)	kWh/cycle	0.214
Weighted energy consumption of the eco 40-60 programme (E_w)	kWh/cycle	0.473
Standard energy consumption of the eco 40-60 programme (SCE_w)	kWh/cycle	0.909
Energy Efficiency Index (EEL_w)	—	52.0
Water consumption of the eco 40-60 programme at rated capacity ($W_{w,full}$)	L/cycle	50.0
Water consumption of the eco 40-60 programme at half rated capacity ($W_{w,1/2}$)	L/cycle	35.0
Water consumption of the eco 40-60 programme at quarter rated capacity ($W_{w,1/4}$)	L/cycle	25.0
Weighted water consumption (W_w)	L/cycle	37
Washing efficiency index of the eco 40-60 programme at rated capacity (I_w)	—	1.031
Washing efficiency index of the eco 40-60 programme at half rated capacity (I_w)	—	1.031
Washing efficiency index of the eco 40-60 programme at quarter rated capacity (I_w)	—	1.031
Rinsing effectiveness of the eco 40-60 programme at rated capacity (I_R)	g/kg	5.0
Rinsing effectiveness of the eco 40-60 programme at half rated capacity (I_R)	g/kg	5.0
Rinsing effectiveness of the eco 40-60 programme at quarter rated capacity (I_R)	g/kg	5.0
Programme duration of the eco 40-60 programme at rated capacity (t_w)	h:min	3:38
Programme duration of the eco 40-60 programme at half rated capacity (t_w)	h:min	2:50
Programme duration of the eco 40-60 programme at quarter rated capacity (t_w)	h:min	2:50
Temperature reached for minimum 5 min inside the load during eco 40-60 programme at rated capacity (T)	°C	33
Temperature reached for minimum 5 min inside the load during eco 40-60 programme at half rated capacity (T)	°C	28
Temperature reached for minimum 5 min inside the load during eco 40-60 programme at quarter rated capacity (T)	°C	23
Spin speed in the spinning phase of the eco 40-60 programme at rated capacity (S)	rpm	1400
Spin speed in the spinning phase of the eco 40-60 programme at half rated capacity (S)	rpm	1400
Spin speed in the spinning phase of the eco 40-60 programme at quarter rated capacity (S)	rpm	1400
Weighted remaining moisture content (D)	%	53.9
Airborne acoustical noise emissions during eco 40-60 programme (spinning phase)	dB(A) re 1 pW	76
Power consumption in 'off mode' (P_o)	W	0.52
Power consumption in 'standby mode' (P_{sm})	W	N/A
Does 'standby mode' include the display of information?	—	NO
Power consumption in 'standby mode' (P_{sm}) in condition of networked standby (if applicable)	W	N/A
Power consumption in 'delay start' (P_{ds}) (if applicable)	W	4.00

PRODUCT FICHE

Supplier's name or trade mark:

Supplier's address ^(*):

Model identifier: P35149SKW-A

General product parameters:

Parameter	Value		Parameter	Value	
Rated capacity ^(*) (kg)	9.0		Dimensions in cm	Height	85
				Width	60
				Depth	60
EE _w ^(*)	51.9		Energy efficiency class ^(*)	A	
Washing efficiency index ^(*)	1.031		Rinsing effectiveness (g/kg) ^(*)	5.0	
Energy consumption in kWh per cycle, based on the eco 40-60 programme. Actual energy consumption will depend on how the appliance is used.	0.494		Water consumption in litre per cycle, based on the eco 40-60 programme. Actual water consumption will depend on how the appliance is used and on the hardness of the water.	45	
Maximum temperature inside the treated textile ^(*) (°C)	Rated capacity	30	Remaining moisture content ^(*) (%)	53.9	
	Half	29			
	Quarter	21			
Spin speed ^(*) (rpm)	Rated capacity	1400	Spin-drying efficiency class ^(*)	B	
	Half	1400			
	Quarter	1400			
Programme duration ^(*) (h:min)	Rated capacity	3:48	Type	free-standing	
	Half	2:54			
	Quarter	2:54			
Airborne acoustical noise emissions in the spinning phase ^(*) (dB(A) re 1 pW)	76		Airborne acoustical noise emission class ^(*) (spinning phase)	B	
Off-mode (W)	0.50		Standby mode (W)	N/A	
Delay start (W) (if applicable)	4.00		Networked standby (W) (if applicable)	N/A	

Minimum duration of the guarantee offered by the supplier ^(*):

This product has been designed to release silver ions during the washing cycle

NO

Additional information:

Weblink to the supplier's website, where the information in point 9 of Annex II to Commission Regulation (EU) 2019/2023 (1) (b) is found:

^(*) for the eco 40-60 programme.

^(*) changes to these items shall not be considered relevant for the purposes of paragraph 4 of Article 4 of Regulation (EU) 2017/1369.

^(*) if the product database automatically generates the definitive content of this cell the supplier shall not enter these data.

Information to be included in the technical documentation for household washing machines

PARAMETER	UNIT	VALUE
Rated capacity for the eco 40-60 programme, at 0,5 kg intervals (c)	kg	9.0
Energy consumption of the eco 40-60 programme at rated capacity ($E_{w,full}$)	kWh/cycle	0.794
Energy consumption of the eco 40-60 programme at half rated capacity ($E_{w,1/2}$)	kWh/cycle	0.494
Energy consumption of the eco 40-60 programme at quarter rated capacity ($E_{w,1/4}$)	kWh/cycle	0.240
Weighted energy consumption of the eco 40-60 programme (E_w)	kWh/cycle	0.494
Standard energy consumption of the eco 40-60 programme (SCE_w)	kWh/cycle	0.951
Energy Efficiency Index (EEI_w)	—	51.9
Water consumption of the eco 40-60 programme at rated capacity ($W_{w,full}$)	L/cycle	60.0
Water consumption of the eco 40-60 programme at half rated capacity ($W_{w,1/2}$)	L/cycle	40.0
Water consumption of the eco 40-60 programme at quarter rated capacity ($W_{w,1/4}$)	L/cycle	35.0
Weighted water consumption (W_w)	L/cycle	45
Washing efficiency index of the eco 40-60 programme at rated capacity (I_w)	—	1.031
Washing efficiency index of the eco 40-60 programme at half rated capacity (I_w)	—	1.031
Washing efficiency index of the eco 40-60 programme at quarter rated capacity (I_w)	—	1.031
Rinsing effectiveness of the eco 40-60 programme at rated capacity (I_R)	g/kg	5.0
Rinsing effectiveness of the eco 40-60 programme at half rated capacity (I_R)	g/kg	5.0
Rinsing effectiveness of the eco 40-60 programme at quarter rated capacity (I_R)	g/kg	5.0
Programme duration of the eco 40-60 programme at rated capacity (t_w)	h:min	3:48
Programme duration of the eco 40-60 programme at half rated capacity (t_w)	h:min	2:54
Programme duration of the eco 40-60 programme at quarter rated capacity (t_w)	h:min	2:54
Temperature reached for minimum 5 min inside the load during eco 40-60 programme at rated capacity (T)	°C	30
Temperature reached for minimum 5 min inside the load during eco 40-60 programme at half rated capacity (T)	°C	29
Temperature reached for minimum 5 min inside the load during eco 40-60 programme at quarter rated capacity (T)	°C	21
Spin speed in the spinning phase of the eco 40-60 programme at rated capacity (S)	rpm	1400
Spin speed in the spinning phase of the eco 40-60 programme at half rated capacity (S)	rpm	1400
Spin speed in the spinning phase of the eco 40-60 programme at quarter rated capacity (S)	rpm	1400
Weighted remaining moisture content (D)	%	53.9
Airborne acoustical noise emissions during eco 40-60 programme (spinning phase)	dB(A) re 1 pW	76
Power consumption in 'off mode' (P_o)	W	0.50
Power consumption in 'standby mode' (P_{sm})	W	N/A
Does 'standby mode' include the display of information?	—	NO
Power consumption in 'standby mode' (P_{sm}) in condition of networked standby (if applicable)	W	N/A
Power consumption in 'delay start' (P_{ds}) (if applicable)	W	4.00

PRODUCT FICHE

Supplier's name or trade mark:

Supplier's address ^(b):

Model identifier: P351410SKW-A P351410SYIN-A

General product parameters:

Parameter	Value		Parameter	Value	
Rated capacity ^(a) (kg)	10.0		Dimensions in cm	Height	85
				Width	60
				Depth	60
EE _w ^(a)	52.0		Energy efficiency class ^(a)	A	
Washing efficiency index ^(a)	1.031		Rinsing effectiveness (g/kg) ^(a)	5.0	
Energy consumption in kWh per cycle, based on the eco 40-60 programme. Actual energy consumption will depend on how the appliance is used.	0.514		Water consumption in litre per cycle, based on the eco 40-60 programme. Actual water consumption will depend on how the appliance is used and on the hardness of the water.	51	
Maximum temperature inside the treated textile ^(a) (°C)	Rated capacity	33	Remaining moisture content ^(a) (%)	53.9	
	Half	29			
	Quarter	20			
Spin speed ^(a) (rpm)	Rated capacity	1400	Spin-drying efficiency class ^(a)	B	
	Half	1400			
	Quarter	1400			
Programme duration ^(a) (h:min)	Rated capacity	3:59	Type	free-standing	
	Half	3:00			
	Quarter	3:00			
Airborne acoustical noise emissions in the spinning phase ^(a) (dB(A) re 1 pW)	76		Airborne acoustical noise emission class ^(a) (spinning phase)	B	
Off-mode (W)	0.50		Standby mode (W)	N/A	
Delay start (W) (if applicable)	4.00		Networked standby (W) (if applicable)	N/A	

Minimum duration of the guarantee offered by the supplier ^(b):

This product has been designed to release silver ions during the washing cycle

NO

Additional information:

Weblink to the supplier's website, where the information in point 9 of Annex II to Commission Regulation (EU) 2019/2023 (1) (b) is found:

^(a) for the eco 40-60 programme.

^(b) changes to these items shall not be considered relevant for the purposes of paragraph 4 of Article 4 of Regulation (EU) 2017/1369.

^(c) if the product database automatically generates the definitive content of this cell the supplier shall not enter these data.

Information to be included in the technical documentation for household washing machines

PARAMETER	UNIT	VALUE
Rated capacity for the eco 40-60 programme, at 0,5 kg intervals (c)	kg	10.0
Energy consumption of the eco 40-60 programme at rated capacity ($E_{w,full}$)	kWh/cycle	0.900
Energy consumption of the eco 40-60 programme at half rated capacity ($E_{w,1/2}$)	kWh/cycle	0.535
Energy consumption of the eco 40-60 programme at quarter rated capacity ($E_{w,1/4}$)	kWh/cycle	0.245
Weighted energy consumption of the eco 40-60 programme (E_w)	kWh/cycle	0.514
Standard energy consumption of the eco 40-60 programme (SCE_w)	kWh/cycle	0.988
Energy Efficiency Index (EEL_w)	—	52.0
Water consumption of the eco 40-60 programme at rated capacity ($W_{w,full}$)	L/cycle	65.0
Water consumption of the eco 40-60 programme at half rated capacity ($W_{w,1/2}$)	L/cycle	55.0
Water consumption of the eco 40-60 programme at quarter rated capacity ($W_{w,1/4}$)	L/cycle	40.0
Weighted water consumption (W_w)	L/cycle	51
Washing efficiency index of the eco 40-60 programme at rated capacity (I_w)	—	1.031
Washing efficiency index of the eco 40-60 programme at half rated capacity (I_w)	—	1.031
Washing efficiency index of the eco 40-60 programme at quarter rated capacity (I_w)	—	1.031
Rinsing effectiveness of the eco 40-60 programme at rated capacity (I_R)	g/kg	5.0
Rinsing effectiveness of the eco 40-60 programme at half rated capacity (I_R)	g/kg	5.0
Rinsing effectiveness of the eco 40-60 programme at quarter rated capacity (I_R)	g/kg	5.0
Programme duration of the eco 40-60 programme at rated capacity (t_w)	h:min	3:59
Programme duration of the eco 40-60 programme at half rated capacity (t_w)	h:min	3:00
Programme duration of the eco 40-60 programme at quarter rated capacity (t_w)	h:min	3:00
Temperature reached for minimum 5 min inside the load during eco 40-60 programme at rated capacity (T)	°C	33
Temperature reached for minimum 5 min inside the load during eco 40-60 programme at half rated capacity (T)	°C	29
Temperature reached for minimum 5 min inside the load during eco 40-60 programme at quarter rated capacity (T)	°C	20
Spin speed in the spinning phase of the eco 40-60 programme at rated capacity (S)	rpm	1400
Spin speed in the spinning phase of the eco 40-60 programme at half rated capacity (S)	rpm	1400
Spin speed in the spinning phase of the eco 40-60 programme at quarter rated capacity (S)	rpm	1400
Weighted remaining moisture content (D)	%	53.9
Airborne acoustical noise emissions during eco 40-60 programme (spinning phase)	dB(A) re 1 pW	76
Power consumption in 'off mode' (P_o)	W	0.50
Power consumption in 'standby mode' (P_{sm})	W	N/A
Does 'standby mode' include the display of information?	—	NO
Power consumption in 'standby mode' (P_{sm}) in condition of networked standby (if applicable)	W	N/A
Power consumption in 'delay start' (P_{ds}) (if applicable)	W	4.00

Health & Safety

location

- This appliance is intended to be used in household and residential type environments. It is not suitable for use in shops, offices and other working environments
- Do not use outdoors or in a bathroom
- Do not place appliance on a highly polished wooden surface as damage may occur to the surface
- Do not place the appliance on or near a hot surface
- This appliance should not be used in an unheated, cold room i.e. Garage, conservatory, annex, shed, out-house etc.

Mains Cable

- Do not let the lead run across an open space
- Do not let the cable run across a cooker or hot area which may damage the cable
- The mains cable should reach from the socket to the base unit without straining the connections
- The power cord cannot be replaced

Personal Safety

- Do not touch discharging hose or water as they may reach high temperatures and risk burning
- To protect against the risk of electric shock ensure the electrical connections are kept dry
- This appliance is not intended for use by persons (including children) with reduced physical, sensory or mental capabilities

Children

- Children should be supervised to ensure that they do not play with this appliance
- Teach children to be aware of dangers in the kitchen
- Do not allow children to play with the appliance or tamper with the controls
- Children under the age of 8 should not use this appliance

Other Safety Considerations

- Do not operate any appliance with a damaged cord or plug or after the appliance malfunctions or has been damaged in any manner
- Do not use the appliance for anything other than its intended purpose
- Unplug from the outlet when not in use or unattended and before assembling, disassembling and cleaning
- Make sure the appliance is switched off before connecting to or disconnecting from the mains supply
- If the appliance is dropped or damaged in any manner, return the appliance to the nearest authorized dealer or after-sales service centre for examination, repair, electrical or mechanical adjustment

POWERPOINT STANDARD MANUFACTURER WARRANTY

TERMS AND CONDITIONS

This appliance was supplied by Shomar Ltd, Dublin. Combining years of knowledge and experience with our commitment to producing high quality appliances is what make us the country's best, fully Irish owned, Domestic Appliance Distributor. We provide all after sales service from our Headquarters in Dublin.

12 Month Warranty

This Warranty is for 12 Months from Date of Purchase and covers both Parts & Labour. Any complaints that occur during normal use of these appliances will be repaired free of charge provided the appliance has been used and maintained in accordance with the Terms and Conditions.

If a repair to your appliance is necessary evidence of purchase will be required for a call to be covered by your Warranty.

Two-year Warranty

You must register your new appliance with Shomar to avail of the **FREE** two (2) Year Warranty. Registering your appliance will allow us to contact you in the unlikely event that a modification is required. In case of an insurance loss such as theft, fire or flood, your registration will serve as proof of purchase.

Terms and Conditions

The Warranty only covers the appliance for use in a normal domestic environment. Institutional use or commercial use is not covered. (To obtain a commercial Warranty on your appliance contact us on service@shomar.ie for more details)

The following is not covered by the Warranty:

- Complaints due to the use of incorrect voltage.
- Failure of the water supply
- Failure of the electricity supply
- Failure to operate the appliance in line with the guidelines set out in the instruction manual.
- Damage to the appliance or its components however caused.
- Consumable items. E.g. Fuses, bulbs, broken glass, Knobs, Plastics.
- Blockages of Filters, drainage systems, soap dispensers etc

Note:

- Repairs or modifications carried out by anyone other than Shomar authorised agents will deem the Warranty Null and Void.

- All Gas appliances must by law be fitted by a Registered Gas Installer. For further details see WWW.RGI.IE

- Built In appliance installation and reversing the door hinges must be undertaken by a competent person.

- If in any doubt about the installation of our domestic appliances please contact us on 01-4505327 for more details.

How to log a service call:

If in the event you need to log a service call for your appliance you can contact our service department on 01-4505327 or go online to www.shomar.ie.

This Warranty does not in any way diminish or affect your statutory rights in connection with the product. This Warranty is in addition to your statutory rights as a consumer. If you have any questions about these rights, please contact the retailer from which you purchased the product. In certain circumstances, it is possible that your statutory rights may offer additional or higher levels of protection than those offered under the terms of this Warranty.

This Warranty applies only to the cost of repairing the product. To the extent permitted by law, the Manufacturer does not accept and will not be held liable for any financial loss incurred in connection with the failure of any product to operate in accordance with the expected standards. Such financial loss includes but is not limited to loss arising from:

- Food Loss
- Time taken from work
- Damaged clothing or other items
- Laundry costs
- Meals from Restaurant /Takeaways
- General Compensation for Inconvenience

Does PowerPoint offer replacements?

This is a repair-only Warranty. On occasion, the Manufacturer may at its sole discretion, replace your product with a new product instead of carrying out a repair. In the unlikely event we cannot repair your appliance it will be replaced free of charge, replacement will be authorised and provided by the retailer upon contact from the manufacturer.

Any costs related to disconnecting the faulty product and installing the replacement product will not be borne by the Manufacturer unless previously agreed to in writing.

The original Warranty will continue to apply to the replacement product; the new product will not come with a new Warranty.

Will I be charged for the repairs?

It is the responsibility of the consumer to provide proof of purchase to the Engineer to ensure your product is covered by this warranty. The Manufacturer reserves the right to charge for service call if:

- You cannot provide proof of purchase that your product is covered by this Warranty.
- The engineer finds that there is no fault with your product.
- That your product has not been installed or operated in accordance with the User Manual.
- That the fault was caused by something other than faulty materials, defective components or manufacturing defects.
- For missed appointments.

Payment is due immediately upon the Engineer providing you with an invoice. The Manufacturer reserves the right to terminate the Warranty if you fail to pay the costs for the service call.

This appliance was supplied by Shomar Ltd Dublin. If you would like to contact us in relation to your product we can be contacted on 01-4505237 or service@shomar.ie

The model information as stored in the product database can be reached by visiting <https://eprel.ec.europa.eu/> and entering the following registration numbers:

**P351410SYIN-A - 2039239
P35148SSYIN-A - 2039337
P35106SYIN-A - 2039370
P35149SKW-A - 2040766
P351410SKW A - 1989989
P35148SKW A - 1994653
P35147SKW A - 1994873
P35106SKW A - 1994909**

