

Powerpoint Freestanding oven

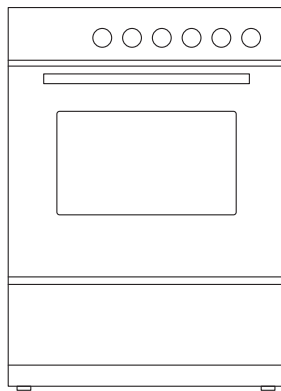

MODEL: P05E1MDW/P05E1WDBL

Instructions for installation and use.

Photos are only for reference, there might be difference between models.

CONTENTS

SAFETY INSTRUCTIONS	02
SPECIFICATIONS	08
PRODUCT OVERVIEW	09
QUICK START GUIDE	10
PRODUCT INSTALLATION	13
OPERATION INSTRUCTIONS	18
CLEANING AND MAINTENANCE	20
TROUBLESHOOTING	21
DISPOSAL AND RECYCLING	22

SAFETY INSTRUCTIONS

Intended use

The following safety guidelines are intended to prevent unforeseen risks or damage from unsafe or incorrect operation of the appliance. Please check the packaging and appliance on arrival to make sure everything is intact to ensure safe operation. If you find any damage, please contact the retailer or dealer. Please note modifications or alterations to the appliance are not allowed for your safety concern. Unintended use may cause hazards and loss of warranty claims.

Explanation of symbols



Danger

This symbol indicates that there are dangers to the life and health of persons due to extremely flammable gas.



Warning of electrical voltage

This symbol indicates that there is a danger to life and health of persons due to voltage.



Warning

The signal word indicates a hazard with a medium level of risk which, if not avoided, may result in death or serious injury.



Caution

The signal word indicates a hazard with a low degree of risk which, if not avoided, may result in minor or moderate injury.



Attention

The signal word indicates important information (e.g. damage to property), but not danger.



Observe instructions

This symbol indicates that a service technician should only operate and maintain this appliance in accordance with the operating instructions.

Read these operating instructions carefully and attentively before using/commis-
sioning the unit and keep them in the immediate vicinity of the installation site or
unit for later use!

SAFETY INSTRUCTIONS

- 01 **WARNING:** This appliance is not intended for use by persons (including children) with reduced physical, sensory or mental capabilities, or lack of experience and knowledge, unless they have been given supervision or instruction concerning use of the appliance by a person responsible for their safety.
- 02 Children should be supervised to ensure that they do not play with the appliance.
- 03 If the supply cord is damaged, it must be replaced by the manufacturer, its service agent or similarly qualified persons in order to avoid a hazard.
- 04 **WARNING:** Ensure that the appliance is switched off before replacing the lamp to avoid the possibility of electric shock.
- 05 Steam cleaner is not to be used.
- 06 Surface of a storage drawer can get hot.
- 07 Do not use harsh abrasive cleaners or sharp metal scrapers to clean the oven door glass since they can scratch the surface, which may result in shattering of the glass.
- 08 **WARNING:** The appliance and its accessible parts become hot during use. Care should be taken to avoid touching heating elements. Children less than 8 years of age shall be kept away unless continuously supervised.
- 09 During use the appliance becomes hot. Care should be taken to avoid touching heating elements inside the oven.
- 10 **WARNING:** Accessible parts may become hot during use. Young children should be kept away.
- 11 Only use the temperature probe recommended for this oven. (Models with probes.)
- 12 The appliance must not be installed behind a decorative door in order to avoid overheating.
- 13 Necessity to allow disconnection of the appliance from the supply after installation, unless the appliance incorporates a switch complying with 24.3. The disconnection may be achieved by having the plug accessible or by incorporating a switch in the fixed wiring in accordance with the wiring rules.

- 14 After removing the packaging, check that the appliance is not damaged. If you have any doubt, do not use the appliance, contact your nearest service centre of the store where you buy the appliance.
- 15 Keep packaging components (plastic bags, Styrofoam, nails, etc.) out of the reach of children as they are a source of potential hazards.
- 16 The appliance must be installed only by a qualified person in compliance with the instructions provided. The manufacturer declines all responsibility for improper installation which may harm persons and animals and damage property.
- 17 The electrical safety of this appliance can only be guaranteed if the cooker is correctly and efficiently earthed, in compliance with current regulations on electrical safety. Always ensure that the earthing is efficient; if you have any doubts call in a qualified electrician to check the system. The manufacturer declines all responsibility for damage resulting from a system which has not been earthed.
- 18 Check that the electrical capacity of the system and sockets will support the maximum power of the hob, as indicated on the rating label. If you have any doubts, call in a qualified technician.
- 19 There may be an unpleasant odor upon first use, which disappears after a period of use.
- 20 When first using the cooker, ensure that the room is well ventilated (e.g. open a window or use an extractor fan) and that persons who may be sensitive to the odour avoid any fumes. It is suggested that any pets be removed from the room until the smell has ceased. This odour is due to temporary finish on oven liners and elements and also any moisture absorbed by the insulation.
- 21 Ensure that the appliance is switched off before maintenance, by switching off the main switches and turning all knobs to "OFF" position.
- 22 The openings and slots used for ventilation and dispersion of heat on the rear and below the control panel must never be covered.
- 23 The user must not replace the supply cable of this appliance. Always call an after-sales servicing centre authorized by the seller in the case of cable damage or replacement.

- 24 The user must not replace the supply cable of this appliance. Always call an after-sales servicing centre authorized by the seller in the case of cable damage or replacement.
- 25 This appliance must be used for the purpose for which it was expressly designed. Any other use is considered to be improper and consequently dangerous. The manufacturer declines all responsibility for damage resulting from improper and irresponsible use.
- 26 A number of fundamental rules must be followed when using electrical appliances. The following are of particular importance:
 - Do not touch the appliance when your hands or feet are wet .
 - Do not use the appliance barefooted.
 - Never allow the Mains Cable to be stretched, pulled or damaged if the Cooker is moved for cleaning etc. Do not use the cooker if the Mains Cable is damaged, consult a qualified electrician.
 - Do not allow the cooker to be used unsupervised by children or persons unfamiliar with it.
- 27 Always switch off the electrical supply to the cooker and allow it to cool down before carrying out any cleaning operations etc.
- 28 Danger of fire: do not store items on the cooker surfaces.
- 29 To avoid accidental spillage do not use cookware with uneven or deformed bottoms on the burners or on the electric plates.
- 30 Special care should be taken when using chip pans etc. in order to avoid splashing or spillage of hot oil. They should not be used unattended since overheated oil may boil over and could also ignite.
- 31 Parts of this appliance, cooking surfaces, retain heat for considerable periods after switching off. Care should, therefore, be taken when touching these areas before they have completely cooled down.
- 32 Never use flammable liquids such as alcohol or gasoline, etc. near the appliance when it is in use.
- 33 When using small electrical appliances near the hob, keep the supply cord away from the hot parts.

- 34 Make sure the knobs are in its “OFF” position when the appliance is not in use. Also make all potentially dangerous parts of the appliance, safe, above all for children who could play with the appliance.
- 35 When the appliance is in use the, heating elements and some parts of the oven door become extremely hot. Make sure you don't touch them and keep children well away.
- 36 If you use the power cable for single phase, the minimum cross-sectional area is 10mm² . For three phases, the minimum cross-sectional area is 2.5mm² .
- 37 Any spillage should be removed from the lid before opening and the hob surface should be allowed to cool before closing the lid.
- 38 You must close the door when grill.

Safety Information

Always

- 01 Turn controls off when you have finished cooking and when not in use.
- 02 Stand back when opening an oven door to allow any build up of steam or heat to disperse. Use dry good quality oven gloves when removing items from the oven/grill.
- 03 Place pans centrally over the hotplate making sure handles are kept away from the edge of the hob and cannot become heated by other hotplate/pans.
- 04 Take care to avoid heat/steam burns when operating the controls.
- 05 Turn off the electricity supply before cleaning and allow the appliance to cool.
- 06 Make sure the shelves are in the correct position before switching on the oven.
- 07 Take care when removing items from the grill when the lower oven is on as the contents will be hot.
- 08 Keep the appliance clean, as a build up of grease or fat from cooking can cause a fire.
- 09 Follow the basic principles of food handling and hygiene to prevent the possibility of bacterial growth.
- 10 Keep ventilation slots clear of obstructions.
- 11 Refer servicing to a qualified appliance service engineer.
- 12 Take care to avoid touching heating elements inside the oven, as during use the oven becomes hot.

Never

- 01 Never line the interior of the oven with foil as this may cause the appliance to overheat.
- 02 Never leave children unsupervised where a cooking appliance is installed as all surfaces will be hot during and after its use.
- 03 Do not allow children or persons who are not familiar with the appliance to use it, without supervision.
- 04 Never allow anyone to sit or stand on any part of the appliance.
- 05 Never store items above the appliance that children may attempt to reach.
- 06 Never leave anything on the hob surface when unattended and not in use.
- 07 Never remove the oven shelves whilst the oven is hot.
- 08 Never heat up unopened food containers as pressure can build up causing the container to burst.
- 09 Never store chemicals/food stuffs, pressurized container in or on the appliance, or in cabinets immediately above or next to the appliance.
- 10 Never place flammable or plastic items on or near the hob.
- 11 Never fill a deep fat frying pan more than 1/3 full of oil, or use a lid.
Never use the appliance as a room heater.
Never use the grill to warm plates.
Never dry any items on either the hob or oven doors.
Never install the appliance next to curtains or other soft furnishings.
Never use steam cleaners.

Do Not

- 01 Do not cook directly on the hob surface without a cooking utensil, as this will result in damage to the surface of the hob.
- 02 Do not use the hob as a worktop surface as damage may occur to the smooth surface of the hob.
- 03 Do not drag or slide utensils on the hob surface, as this will cause scratches in the surface of the hob.
- 04 Do not allow a cooking utensil to come into contact with the hob surround.
- 05 Do not leave any utensils, food or combustible items on the hob when it is not in use.
- 06 Do not place aluminum or plastic foil, or plastic containers on the hob.
- 07 Do not leave the hotplates or cooking areas switched ON unless they are being used. We recommend not to place large preserving pans or fish kettles across two heating areas.
- 08 Do not leave utensils partly covering the heated areas. Always ensure that are placed centrally over the heated areas and have the same diameter as the heating area used.

SPECIFICATIONS

Power Supply	220-240V- , 50Hz-60Hz
Electric Power	7600W (Oven: 2600W Hob: 5000W)
Hob Size / Power	A=145mm, 1000W
	B=180mm, 1500W
	C=145mm, 1000W
	D=180mm, 1500W

ENERGY EFFICIENCY

Product Information and Product Information Sheet according to EU and UK Ecodesign and Energy Labelling Regulations

Model	PO5E1MDW/PO5E1WDBL
Energy Efficiency Index	93.5
Energy efficiency class	A
Energy consumption with a standard load, conventional mode	0.72kWh/cycle*
Energy consumption with a standard load, fan-forced mode	----kWh/cycle*
Number of cavities	1
Heat source	Electricity
Volume	52L
Type of oven	Free-Standing Oven

ENERGY CONSUMPTION

Product information for power consumption and maximum time to reach applicable low power mode.

Off mode	0.3 W
----------	-------

PRODUCT OVERVIEW

Part name

1. Hob
2. Control panel
3. Door glass
4. Foot

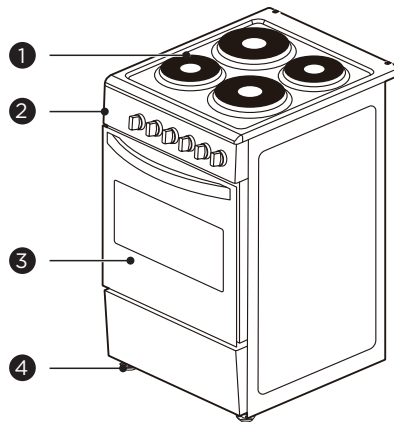

Accessories

The accessories can be inserted in the oven in 4 different shelf positions. You can pull the accessories two-thirds of the way out without them tipping. This allows meals to be removed easily. You can buy accessories from the after-sales service or from specialist retailers.

The level to place the baking rack or tray will depend on the type of the food you want to cook.

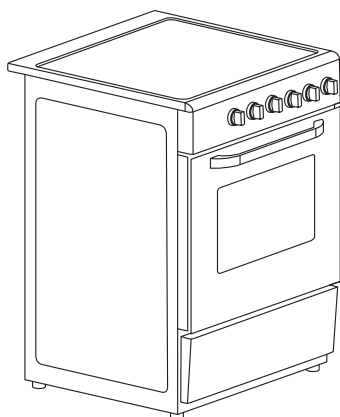

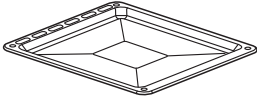
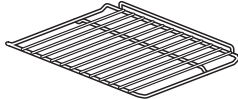
Accessories	Description
	Grill tray Bake or thaw food or collect grease.
	Grill rack Bake cakes or place cooking containers.

QUICK START GUIDE

Control Panel

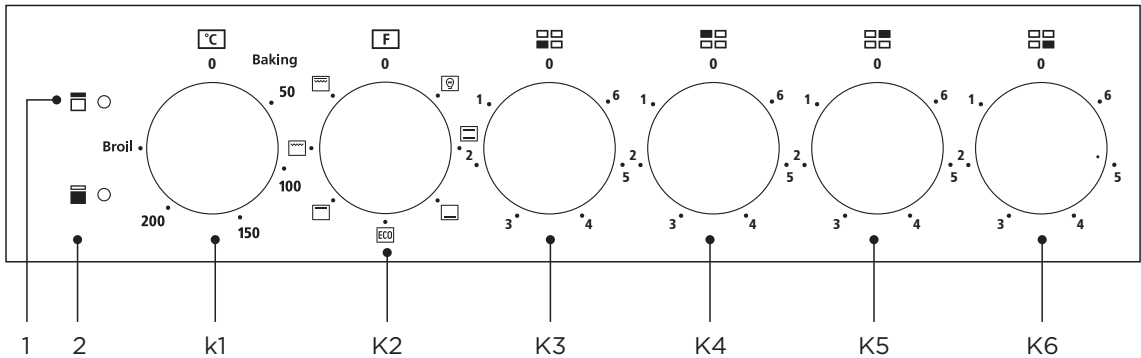

Key 1 : Hob work indicator light







Key 2 : Oven work indicator light

knob K1 : Control oven temperature.

knob K2: Select the oven mode.

knob K3-K6: Select the hob position or adjust the hob power.

Mode introduction

Mode	introduction
 Lamp	The oven lamp is on or off. Turn on the stove light to observe the cooking of the food. Except ECO function.
 Double grilling	The radiant heating element and top heating element are working.
 Radiant grilling	The inner grill element switches on and off to maintain temperature. Can be used to cook a small amount of food.
 Conventional	The top and bottom heating elements work together to provide convectional cooking.
 Bottom heat	Heating is provided by heating pipes at the bottom of the oven. Mainly used for keeping warm and the coloring of the food.
 Top heat	The heating tube at the top of the oven provides heat, suitable for coloring the surface of food.
 ECO	Energy-saving cooking, cooking ingredients in a gentle manner.

Hob introduction

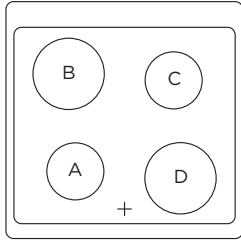

Solid hotplate	Diameter	Electric power
A	145mm	1000W
B	180mm	1500W
C	145mm	1000W
D	180mm	1500W

The knobs for the hobs can be rotated in either direction to provide variable heat control. Turn the hobs control knobs anticlockwise from off position to increase power, there are 6 positions for different power rating.

Note

1. We recommend not to use a utensil with a base diameter greater than 25cm- Pressure cookers or other large pans should be used on the front cooking areas. Always ensure that saucepan handles are positioned safely.
2. Do not use utensils with rough bases.
3. Do not use lightweight utensils with thin, distorted or uneven bases.
4. Do not use lightweight enamelled steel utensils.
5. Do not use cast iron utensils.
6. Do not use utensils with recessed, scrolled or ridged bases.
7. Do not use a utensil which has a base concavity greater than 1mm as this will reduce the performance of the hob.
8. Do not use a utensil with a convex base.
9. Do not use glass ceramic utensils.

This is provided only recommended guide-setting also depend on the type of pan used and the quality of food.

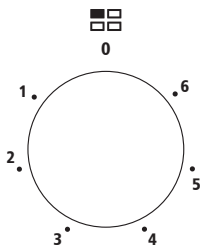

Konb position	Type of foods
1	To melt butter, chocolate, etc.
1 or 2	To heat foods gently. To keep small amount of water simmering. To heat sauces, containing egg yolks and butter. To simmer: stews, meat, fish, vegetables, fruit.
3	To heat solid and liquid foods. Keeps water boiling. Thaw frozen vegetables. Make 2-3 egg omelettes.
4 or 5	To cook foods, just above simmering. To maintain "rolling" boil for preserve making.
5 or 6	To seal meat and fry fish.
6	Frying potatoes. Bringing water to the boil. Deep fat frying. Dissolve sugar for preserve making.

PRODUCT INSTALLATION

Foot installation (Only for some models)

1. The installation process should be done by at least two people wearing scratch-resistant gloves.
2. Install 4 feet to the bottom of the oven.

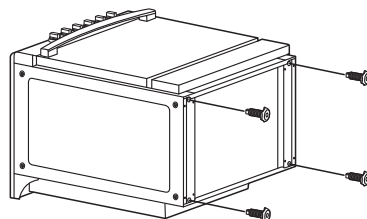
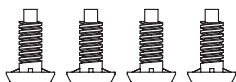

Anti-tipping bracket installation (Only some models)

To prevent the appliance from tipping forward, install an anti-tip bracket.

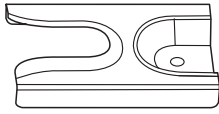

Anti-tilt bracket



Pin



Fixing screws

- 1 Determine the location of the pin hole.

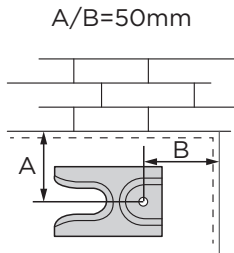

- 2 Make a suitable hole in the ground and insert the pin.

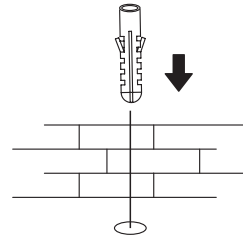

- 3 Align the brackets with the pin holes and secure with screws.

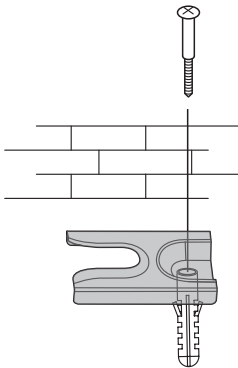

- 4 Snap the two stove feet on the back of the appliance into the brackets.

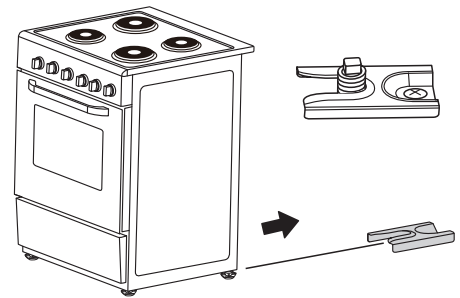

Insulation baffle installation (Only for some models)

Mount the insulating plate to the bottom of the control panel with 3 screws.

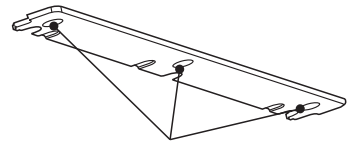
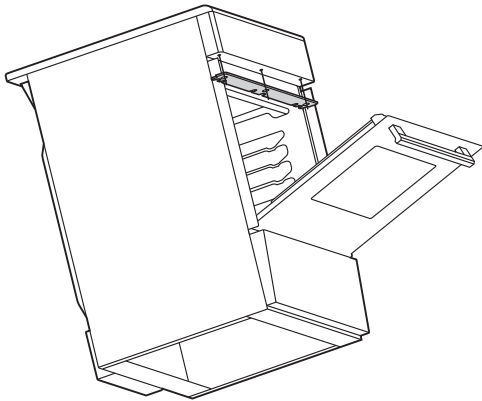

Mounting holes

Insulating baffle

Installation diagram

1. Please customize the Cupboard according to the Cupboard diagram.
2. The Cupboard dimension is in mm.
3. The thickness of Cupboard board is 20 mm.

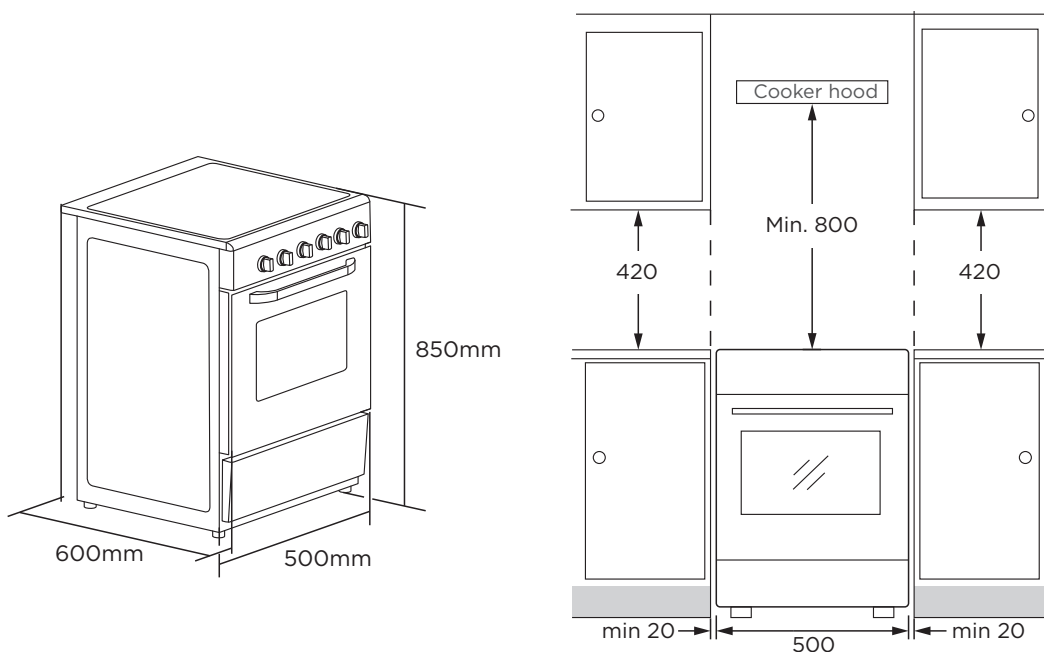

Installation important instructions

1. The following instructions should be read by a qualified technician to ensure that the appliance is installed regulated and technically serviced correctly in compliance with current regulations.
2. Remember to disconnect the appliance from electricity by turning off the mains switch before regulating the appliance or carrying out any maintenance work.
3. The hob should never be installed in proximity of a door access. People opening and closing the door could come into contact with pots or pans cooking on the hob.
4. This equipment may only be installed and used in permanently ventilated rooms.
5. The cooker is designed to fit between kitchen cabinets. The space either side need only be sufficient to allow withdrawal of the cooker for servicing. It can be used with cabinet on one side or both as well as in a corner setting. It can also be used free-standing.
6. The appliances can be installed next to furniture units which are no taller than the top of the cooker hobs. If the cooker is placed touching walls or sides of neighboring cabinets, these must be capable of withstanding a temperature rise of 50 °C above room temperature. For a correct installation of the cooker the following precautions must be followed:
 - A. Cookers can be installed in the kitchen, dining room or living room, but not in the bathroom or shower and on board.
 - B. The wall in contact with the back of the cooker must be of flameproof material.
 - C. The relevant installation dimensions should be carried out in accordance with the "Installation Diagram".
7. The cooker is designed to operate on an electricity supply which conforms to the electrical data shown on the Rating label. The cooker can be connected to the mains only after removing the back panel of the cooker itself with a screwdriver.

OPERATION INSTRUCTIONS

First Use

1. Before using it for the first time, please clean the oven and accessories to a certain extent. Remove the oven packaging shipping protection parts. Remove all accessories (e.g. foam, cardboard, grill tray, grill rack, etc.) from the cavity.
2. Thoroughly clean the attachment with soapy water and a rag or soft brush.
3. Wipe the cavity and oven surfaces with a soft damp cloth.
4. To avoid fire, please make sure that the cavity is free of any remaining packing materials and accessories when using it for the first time.
5. When using it for the first time, keep the kitchen highly ventilated (open the hood and windows). During this time, keep children and pets out of the kitchen and keep the doors of adjacent rooms closed.
6. To remove the smell of new products, run the following:

Oven Mode	Temperature	Time
 Conventional	Broil	0.5 Hour

Oven Operating Steps

1. Turn knob K2 to select oven mode.
2. Turn knob K1 to adjust the temperature.
3. When cooking is finished, turn all knobs to the closed position.

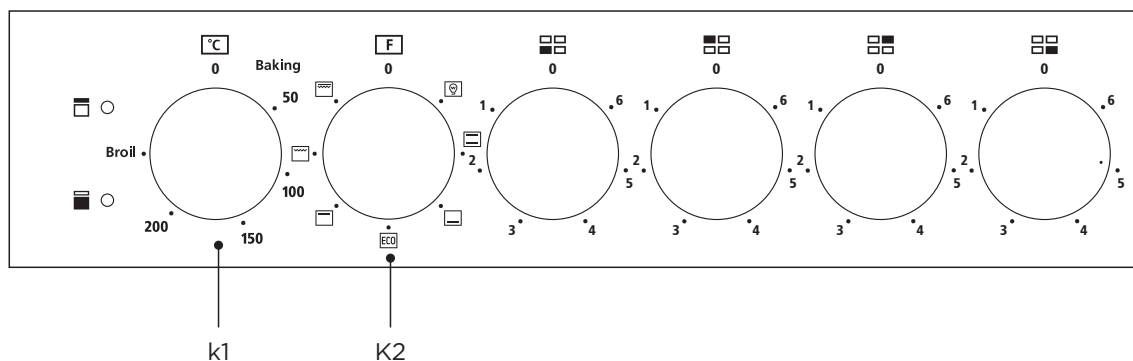

Hob Operating Steps

1. Place a suitable pan in the heating area.
2. Turn the hob knob to select the heating area.
3. When cooking is finished, turn all knobs to the closed position.

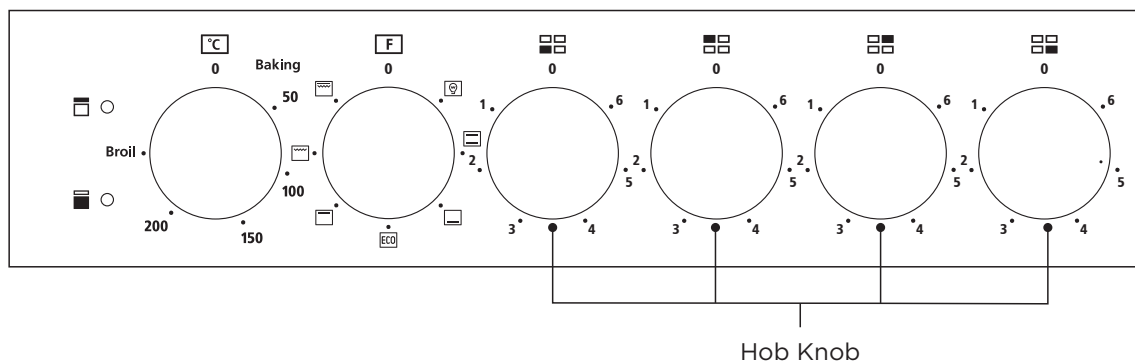

Choosing the Right Cookware

Do not use cookware with jagged edges or a curved base.

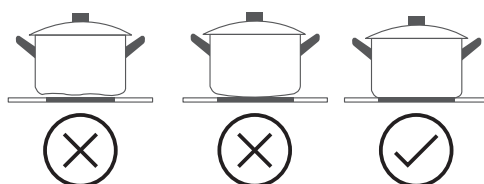

Make sure that the base of your pan is smooth, sits flat against the glass, and is the same size as the cooking zone. Always centre your pan on the cooking zone.

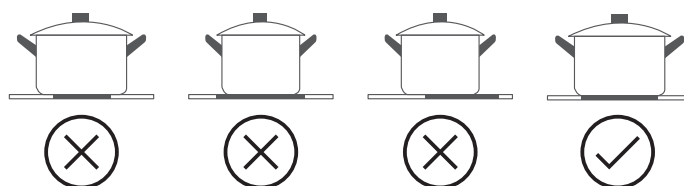

Always lift pans off the ceramic hob - do not slide, or they may scratch the glass.

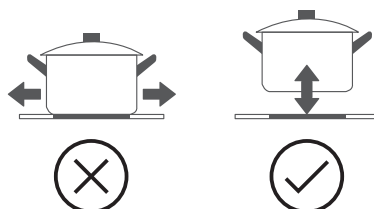

CLEANING AND MAINTENANCE

1. Before cleaning or maintenance, please make sure that the power supply is turned off, the control knob is in the closed position and the cylinder valve is closed.
2. After cooking, wait for the appliance to cool completely before cleaning. Failure to clean the product can cause the surface of the appliance to deteriorate, which can affect the life of the appliance and can lead to a dangerous situation.
3. Cooking utensils (such as: pots, grill tray, grill rack, etc.) should not be washed directly with cold water, but with warm water.
4. Clean the surface of the product with a soft cloth, a hot soapy cloth and a hot soapy water solution (1 liter of water, 2 scoops).
5. When cleaning the control panel and hob, it is recommended to wipe with a dry paper towel moistened with a soapy water solution, then dry with a clean soft cloth or dry paper towel.

NOTE

1. Disconnect power before cleaning or servicing or replacing parts.
2. Always keep your cooker clean.
3. Do not use caustic or strong abrasive cleaners.
4. Do not use hard objects such as wire brushes to wipe the product.
5. Do not use scrubbers as they may damage the look and finish.
6. **WARNING:** Do not use a rough or sharp metal scraper to clean the oven door glass.
7. If the oven door glass surface is scratched, it may shatter and cause injury.

Lamp Replacement

1. To prevent the lamp from being damaged, put a towel in the cavity.
2. Turn counterclockwise to remove the glass cover (corner lamp); Gently pry open the glass cover with a flat-head tool (side lamp).
3. Pull out the wick and replace it (don't turn it).
4. Install the glass cover back and take out the towel.
5. The product contains a light source of energy efficiency class:G.

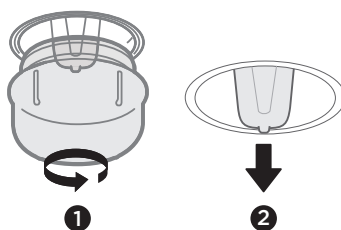

Warning

To avoid electric shocks-please ensure that the electricity supply to the appliance is switched off and the appliance is fully cold. before removing the lamp lens.

TROUBLESHOOTING

Before contacting the authorized service center in case of problems while using your cooker, check the problem quite below; there may be nothing wrong with your cooker.

Problem	Possible reason	Solution
Unable to start	<ul style="list-style-type: none"> • Power is not connected 	<ul style="list-style-type: none"> • connect power supply
	<ul style="list-style-type: none"> • The main power switch is not turned on 	<ul style="list-style-type: none"> • Turn on the power switch
	<ul style="list-style-type: none"> • Oven door not closed 	<ul style="list-style-type: none"> • Close the oven door
lamp does not come on	<ul style="list-style-type: none"> • It's broken 	<ul style="list-style-type: none"> • Contact after-sales service
Has a pungent odor or smoke	<ul style="list-style-type: none"> • first use 	<ul style="list-style-type: none"> • No processing required
Food is not cooked	<ul style="list-style-type: none"> • Temperature is too low 	<ul style="list-style-type: none"> • Use a higher temperature
	<ul style="list-style-type: none"> • Food portion is too large 	<ul style="list-style-type: none"> • Cook food in smaller pieces or extend the cooking time.
Burnt or uneven food	<ul style="list-style-type: none"> • The temperature is set too high or the heating time is too long 	<ul style="list-style-type: none"> • Adjust the cooking temperature or time
	<ul style="list-style-type: none"> • The food is too close to the heating tube 	<ul style="list-style-type: none"> • Adjust the placement layers of accessories

DISPOSAL AND RECYCLING

Important instructions for the environment

Compliance with the WEEE Directive and Disposing of the Waster Product:
This product complies with the EU WEEE Directive (2012/19/EU). This product bears a classification symbol for waster electrical and electronic equipment (WEEE).

This symbol indicates that this product shall not be disposed of with other household wastes at the end of its service life. Used devices must be returned to the oicial collection point for the recycling of electrical electronic devices. To find these collection systems please contact your local authorities or retailer where the product was purchased. Each household performs an important role in recovering and recycling old appliances. Appropriate disposal of used appliances helps prevent potential negative consequences for the environment and human health.



Compliance with RoHS Directive

The product you have purchased complies with the EU RoHS Directive (2011/65/EU). It does not contain harmful and prohibited materials specified in the Directive.

Package information

Packaging materials of the product are manufactured from recyclable materials in accordance with our National Environment Regulations. Do not dispose of the packaging materials together with the domestic or other wastes. Take them to the packaging material collection points designated by the local authorities.



POWERPOINT STANDARD MANUFACTURER WARRANTY

TERMS AND CONDITIONS

This appliance was supplied by Shomar Ltd, Dublin. Combining years of knowledge and experience with our commitment to producing high quality appliances is what make us the country's best, fully Irish owned, Domestic Appliance Distributor. We provide all after sales service from our Headquarters in Dublin.

12 Month Warranty

This Warranty is for 12 Months from Date of Purchase and covers both Parts & Labour. Any complaints that occur during normal use of these appliances will be repaired free of charge provided the appliance has been used and maintained in accordance with the Terms and Conditions.

If a repair to your appliance is necessary evidence of purchase will be required for a call to be covered by your Warranty.

Two-year Warranty

To avail of the second year free warranty, you must register your new appliance with Shomar Ltd. Registering your appliance will also allow us to contact you in the unlikely event that a modification is required. In case of an insurance loss such as theft, fire or flood, your registration will serve as proof of purchase. Scan our QR to register your warranty -



www.powerpointappliances.ie

Terms and Conditions

The Warranty only covers the appliance for use in a normal domestic environment. Institutional use or commercial use is not covered. (To obtain a commercial Warranty on your appliance contact us on service@shomar.ie for more details)

The following is not covered by the Warranty:

- Complaints due to the use of incorrect voltage.
- Failure of the water supply
- Failure of the electricity supply
- Failure to operate the appliance in line with the guidelines set out in the instruction manual.
- Damage to the appliance or its components however caused.
- Consumable items. E.g. Fuses, bulbs, broken glass, Knobs, Plastics.
- Blockages of Filters, drainage systems, soap dispensers etc

Note:

- Repairs or modifications carried out by anyone other than Shomar authorised agents will deem the Warranty Null and Void. Please visit www.powerpointappliances.ie to obtain information on authorised agents.

- All Gas appliances must by law be fitted by a Registered Gas Installer. For further details see WWW.RGI.IE
- Built In appliance installation and reversing the door hinges must be undertaken by a competent person.
- If in any doubt about the installation of our domestic appliances please email us for more details.service@shomar.ie

How to log a service call:

If in the event you need to log a service call for your appliance you can contact our service department on Ph: 01-4505327 (during working hours)

Email service@shomar.ie

Go online www.powerpointappliances.ie

This Warranty does not in any way diminish or affect your statutory rights in connection with the product. This Warranty is in addition to your statutory rights as a consumer. If you have any questions about these rights, please contact the retailer from which you purchased the product. In certain circumstances, it is possible that your statutory rights may offer additional or higher levels of protection than those offered under the terms of this Warranty.

This Warranty applies only to the cost of repairing the product. To the extent permitted by law, the Manufacturer does not accept and will not be held liable for any financial loss incurred in connection with the failure of any product to operate in accordance with the expected standards. Such financial loss includes but is not limited to loss arising from:

- Food Loss
- Time taken from work
- Damaged clothing or other items
- Laundry costs
- Meals from Restaurant /Takeaways
- General Compensation for Inconvenience

Does PowerPoint offer replacements?

This is a repair-only Warranty. On occasion, the Manufacturer may at its sole discretion, replace your product with a new product instead of carrying out a repair. In the unlikely event we cannot repair your appliance it will be replaced free of charge, replacement will be authorised and provided by the retailer upon contact from the manufacturer.

Any costs related to disconnecting the faulty product and installing the replacement product will not be borne by the Manufacturer unless previously agreed to in writing. The original Warranty will continue to apply to the replacement product; the new product will not come with a new Warranty.

Will I be charged for the repairs?

It is the responsibility of the consumer to provide proof of purchase to the Engineer to ensure your product is covered by this warranty. The Manufacturer reserves the right to charge for service call if:

- You cannot provide proof of purchase that your product is covered by this Warranty.
- The engineer finds that there is no fault with your product.
- That your product has not been installed or operated in accordance with the User Manual.
- That the fault was caused by something other than faulty materials, defective components, or manufacturing defects.
- For missed appointments.

Payment is due immediately upon the Engineer providing you with an invoice. The Manufacturer reserves the right to terminate the Warranty if you fail to pay the costs for the service call.

The spare part availability of this appliance is 10 years. During this time, original spare parts will be available to operate the appliance properly.

This appliance was supplied by Shomar Ltd Dublin. If you would like to contact us in relation to your product for service or spare parts we can be contacted on 01-4505327 or service@shomar.ie.

